

SINGLE DUCT AIR TERMINALS

Product Description	B-3 – B-4
Dimensional Data.....	B-5 – B-7
Product Selection Guide.....	B-8 – B-9
Airflow Ranges	B-10 – B-11
Air Pressure Drop Data	B-12
ARI Certified Ratings.....	B-12
Sound Data - EZTS.....	B-13 – B-18
Sound Data - EZTA & EZTE.....	B-19 – B-21
Hot Water Heating Coil Data	B-22 – B-24
Electric Heating Coil Data	B-25
Control Sequence Selection - Pneumatic	B-26
Control Sequence Selection - Electronic Analog.....	B-27
Typical Control Sequences	B-28 – B-32
Features at a Glance	B-33
Typical Specification.....	B-34 – B-36



Flexibility

EZT terminals are available in a wide array of control packages using pneumatic, electronic analog or factory-installed direct digital (DDC) controls.

Hot water heating coils are offered in a wide range of capacities in 1, 2, and 4 rows. Electric heating coils are available in various voltages and steps of control.

Matte-faced insulation is provided as standard. Foil-faced insulation with the edges sealed with either tape or sheet metal (Fibre-Lok) is available. Closed cell (fiber-less) insulation and double wall construction using a full metal liner is also available.

EZT units can be provided with an integral sound attenuator for ultra-quiet performance.

Low temperature unit construction is also available using 1" thick matte-faced insulation and isolation of the air valve from the outer casing.

Numerous other optional features are available including single or double cam lock access doors.

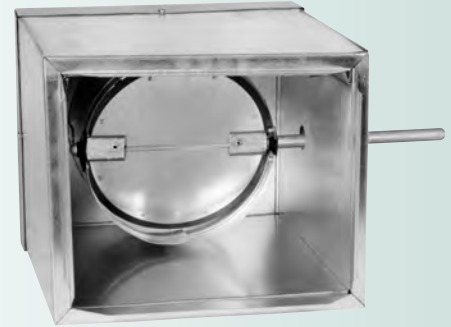

Double Camlock



Hinged, Single Camlock

Performance

Anemostat's EZT terminal ratings are ARI Certified and all units are tested in accordance with ARI Standard 880. The lack of intruding fasteners, tabs or other obstructions in the air stream results in very quiet sound performance and low internal pressure losses. All units incorporate full 90-degree rotation round dampers (except 24 x 16) for precise control of the airflow.

All units are available with pressure independent controls for precise control of the airflow. All units with these controls are factory calibrated for minimum and maximum airflow settings prior to shipment and are easily field adjusted.

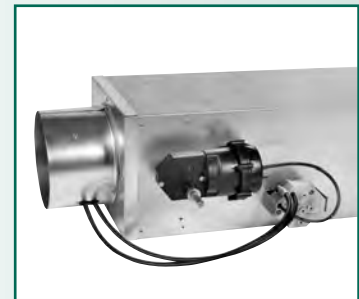

Velocity Wing Air Flow Sensor – The Best in the Industry!!!

The airflow sensor is a very critical component used in air terminals to precisely monitor flow rates into conditioned spaces, and its' performance should not be ignored.



Patented

Anemostat's airflow sensor, the Velocity Wing™, utilizes a patented design that sets the standard for air flow sensing technology used for pressure independent controls systems. The patented design utilized the log-linear rule (ASHRAE Std 111 & AMCA Std 201) to strategically locate the measured points in the air stream. This design feature compensates for frictional drag along the duct walls to obtain the most accurate measurement of flow possible.

High Accuracy

The Velocity Wing™ utilizes 20 measurement points on all 9 inlet sizes (diameters) to accurately measure the airflow, regardless of the upstream velocity profile, with an error less

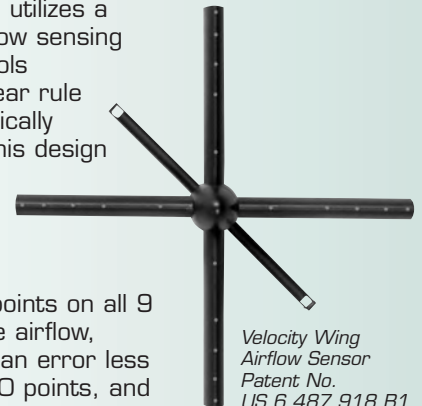

Velocity Wing
Airflow Sensor
Patent No.
US 6,487,918 B1

than 5%. The total pressure is continuously and simultaneously sampled at the 20 points, and averaged in the center chamber. In conjunction with the 2 enhanced amplifying static pick-up tubes, the resultant differential pressure signal is extremely stable and accurate.

Airflow Sensor Comparison

Nom Inlet Dia, in	Nom Area, ft ²	Anemostat Velocity Wing	
		K-Factor, CFM	Pv Amplification
5	0.130	287	3.27
6	0.188	469	2.58
7	0.258	612	2.85
8	0.338	867	2.44
9	0.430	1098	2.46
10	0.532	1353	2.48
12	0.769	1802	2.92
14	1.050	2469	2.90
16	1.375	3366	2.67
Avg Vel Press Amplification=			2.73

Amplification

The Velocity Wing™ amplifies the velocity pressure (on average) 2.73 times which means higher control pressure signals sent to the controller at much lower flow rates. This results in very stable flow control, even with high turn-down ratios. This amplification IS the highest in the industry!!!!

Low Pressure Drop & Sound

The sleek, aerodynamic Velocity Wing creates very little pressure drop for quiet operation and accurate control.

Construction

The Velocity Wing™ is molded from ABS plastic for durability, strength, and lifetime corrosion protection. The flame retardant plastic conforms to UL 95-5VA.

Ease of Installation and Reliability

EZT terminals are compact and utilize inlet collars over 5" in length to allow easy attachment of rigid or flexible duct. The Velocity Wing™ airflow sensor is recessed over 2" into the air valve providing protection from damage. The discharge end of the terminal has slip and drive connections for easy attachment of downstream duct work.

Anemostat's EZT Single Duct terminals are constructed with zinc-coated steel for long life. The unit casings are assembled with a mechanical lock construction that insures a tight seam to minimize air leakage.

Casings are internally lined with a wide variety of insulation and treatment options that conform to NFPA and UL requirements. The leaving edge of the insulation is protected from erosion by return bends on the discharge end of the unit casing.



The damper blade is made of gasket material sandwiched between two round steel plates. The round damper blade in the air valve is affixed to the shaft using through-the-shaft machine applied rivets. The die-cast metal shaft rotates in self-lubricating bearings for easy turning and long operating life. The damper's flexible gasket seats tightly on the cylinder's internal bead for tight closure. A damper position indicator is located on the end of the damper shaft.

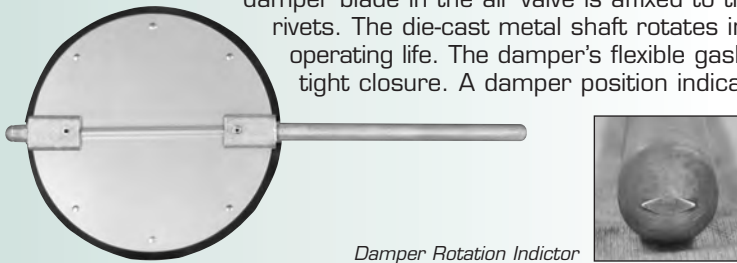

Damper Rotation Indicator



Direct drive actuators are used as standard to eliminate all linkages, and the actuator and controls are attached to the side of the casing allowing for easy accessibility.



Model EZTS Basic Assembly

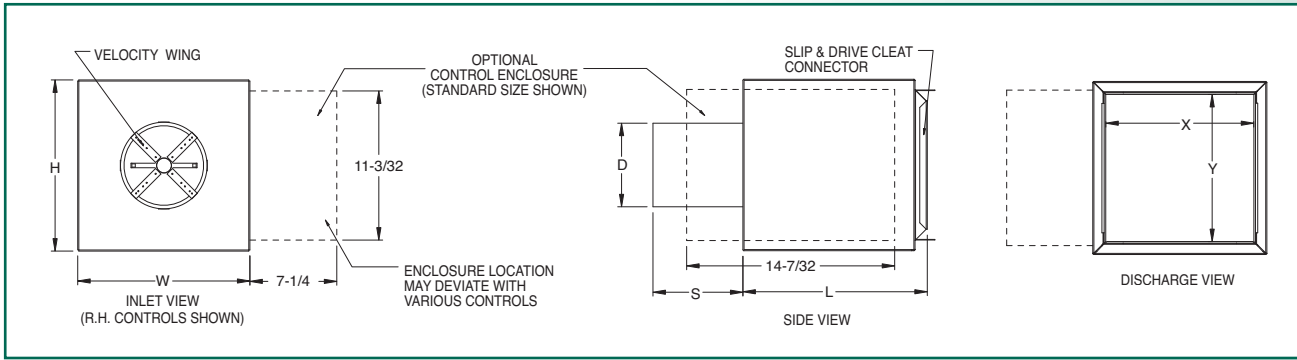

EZTS Units

Inlet Size	CFM Max.	(inches)							Weight (lbs)
		D	W	H	X	Y	L	S	
05	350	4 7/8	10	10	8 3/4	8 3/4	12 1/2	5 3/8	9
06	500	5 7/8	10	10	8 3/4	8 3/4	12 1/2	5 3/8	9
07	675	6 7/8	12	10	10 3/4	8 3/4	12 1/2	5 3/8	11
08	900	7 7/8	12	10	10 3/4	8 3/4	12 1/2	5 3/8	11
09	1100	8 7/8	14	12 1/2	12 3/4	11 1/4	14 1/2	5 3/8	15
10	1400	9 7/8	14	12 1/2	12 3/4	11 1/4	14 1/2	5 3/8	15
12	2000	11 7/8	16	15	14 3/4	13 3/4	18 1/2	5 3/8	19
14	3000	13 7/8	20	17 1/2	18 3/4	16 1/4	18 1/2	5 3/8	23
16	4100	15 7/8	24	17 1/2	22 3/4	16 1/4	18 1/2	5 3/8	28
24x16	7000	24x16	38	18	38	18	30	5 7/16	79

Notes:

- Control enclosure is optional on all units.
- Weights are approximate and will vary based on selected options, insulation type, etc.
- Control enclosures add 5 lbs. to unit weight.
- Right hand connection shown.

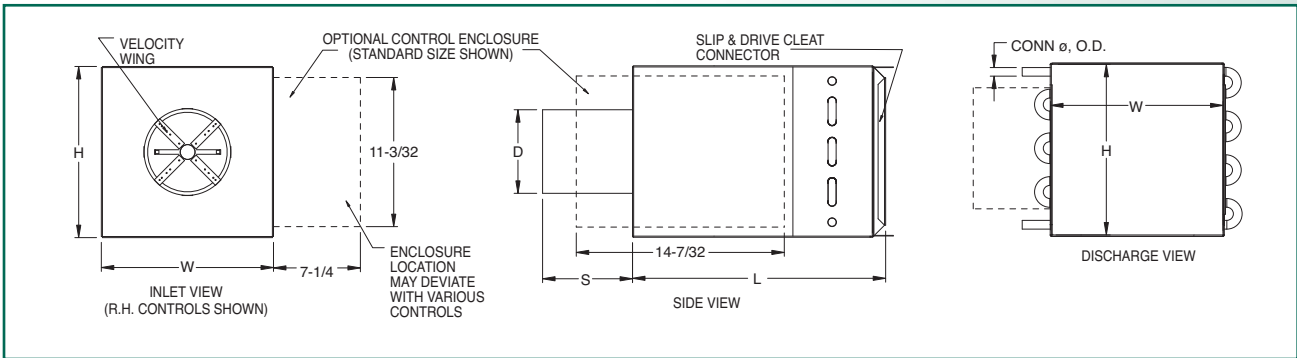

EZTS Units with Hot Water Heating Coil

Inlet Size	CFM Max.	Outlet Size W x H	1 Row			2 Row			4 Row		
			L	Conn.OD	Wgt	L	Conn.OD	Wgt	L	Conn.OD	Wgt
05	350	10 10	16 1/4	1/2	14	17 5/16	1/2	16	19 7/16	7/8	21
06	500	10 10	16 1/4	1/2	14	17 5/16	1/2	16	19 7/16	7/8	21
07	675	12 10	16 1/4	1/2	17	17 5/16	1/2	20	19 7/16	7/8	25
08	900	12 10	16 1/4	1/2	17	17 5/16	1/2	20	19 7/16	7/8	25
09	1100	14 12 1/2	18 1/4	1/2	22	19 5/16	1/2	26	21 7/16	7/8	34
10	1400	14 12 1/2	18 1/4	1/2	22	19 5/16	1/2	26	21 7/16	7/8	34
12	2000	16 15	22 1/4	7/8	28	23 5/16	1/2	34	25 7/16	7/8	43
14	3000	20 17 1/2	22 1/4	7/8	35	23 5/16	7/8	43	25 7/16	7/8	57
16	4100	24 17 1/2	22 1/4	7/8	42	23 5/16	7/8	50	25 7/16	7/8	66
24x16	7000	38 18	35	7/8	101	35	7/8	112	36	1-1/8	135

Notes:

- Male solder connections
- Right and left hand connections available.

Note: All other dimensions same as EZTS

EZTA Units with Integral Sound Attenuator

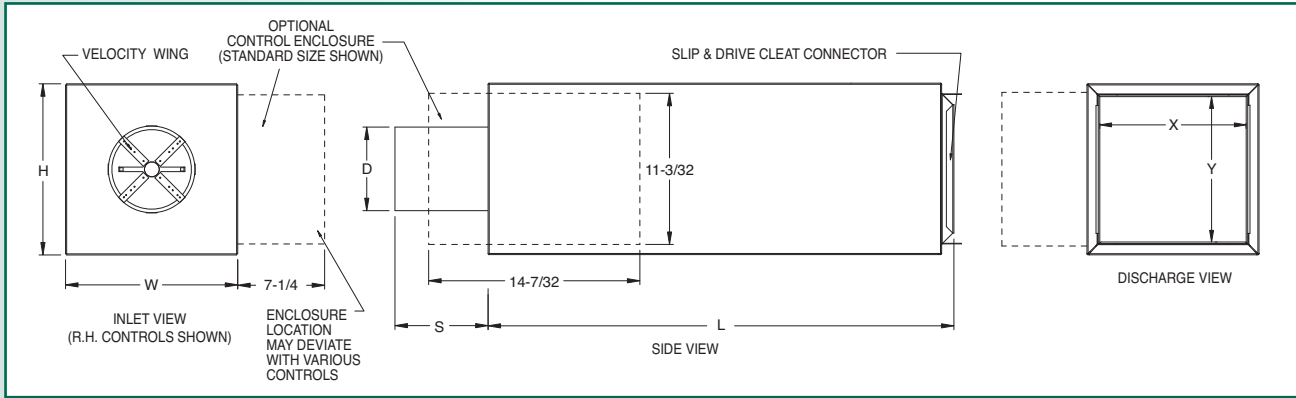

EZTA Units

Inlet Size	CFM Range	(inches)							Weight (lbs)
		D	W	H	X	Y	L	S	
05	0 – 350	4 7/8	10	10	8 3/4	8 3/4	39 1/2	5 3/8	20
06	0 – 500	5 7/8	10	10	8 3/4	8 3/4	39 1/2	5 3/8	20
07	0 – 675	6 7/8	12	10	10 3/4	8 3/4	39 1/2	5 3/8	22
08	0 – 900	7 7/8	12	10	10 3/4	8 3/4	39 1/2	5 3/8	22
09	0 – 1100	8 7/8	14	12 1/2	12 3/4	11 1/4	39 1/2	5 3/8	28
10	0 – 1400	9 7/8	14	12 1/2	12 3/4	11 1/4	39 1/2	5 3/8	28
12	0 – 2000	11 7/8	16	15	14 3/4	13 3/4	39 1/2	5 3/8	32
14	0 – 3000	13 7/8	20	17 1/2	18 3/4	16 1/4	39 1/2	5 3/8	39
16	0 – 4100	15 7/8	24	17 1/2	22 3/4	16 1/4	39 1/2	5 3/8	44
24x16	0 – 7000	24x16	38	18	38	18	42	5 7/16	109

Notes:

- Control enclosure is optional on all units.
- Weights are approximate and will vary based on selected options, insulation type, etc.
- Control enclosures add 5 lbs. to unit weight.
- Right hand connection shown.

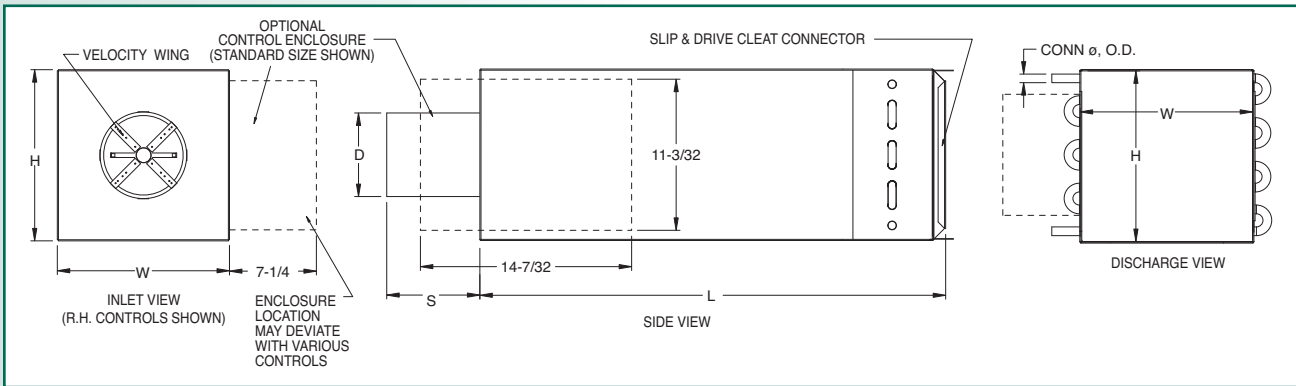

EZTA Units with Hot Water Heating Coil

Inlet Size	CFM Max.	Outlet Size W x H	1 Row			2 Row			4 Row		
			L	Conn.OD	Wgt	L	Conn.OD	Wgt	L	Conn.OD	Wgt
05	350	10 10	43 1/4	1/2	25	44 5/16	1/2	27	46 7/16	7/8	32
06	500	10 10	43 1/4	1/2	25	44 5/16	1/2	27	46 7/16	7/8	32
07	675	12 10	43 1/4	1/2	28	44 5/16	1/2	31	46 7/16	7/8	36
08	900	12 10	43 1/4	1/2	28	44 5/16	1/2	31	46 7/16	7/8	36
09	1100	14 12 1/2	43 1/4	1/2	35	44 5/16	1/2	39	46 7/16	7/8	47
10	1400	14 12 1/2	43 1/4	1/2	35	44 5/16	1/2	39	46 7/16	7/8	47
12	2000	16 15	43 1/4	7/8	41	44 5/16	1/2	47	46 7/16	7/8	56
14	3000	20 17 1/2	43 1/4	7/8	51	44 5/16	7/8	59	46 7/16	7/8	73
16	4100	24 17 1/2	43 1/4	7/8	58	44 5/16	7/8	66	46 7/16	7/8	82
24x16	7000	38 18	47	7/8	131	47	7/8	142	48	1-1/8	165

Notes:

- Male solder connections
- Right and left hand connections available.

Note: All other dimensions same as EZTA

EZTE Units with Integral Electric Heat

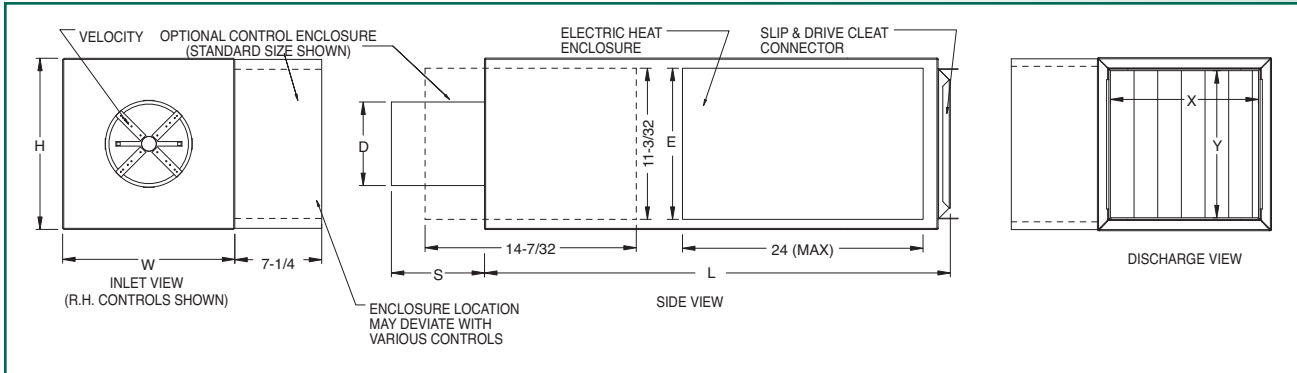

EZTE Units

Inlet Size	CFM Max.	(inches)									Weight (lbs)
		D	W	H	E	X	Y	L	S		
05	350	4 7/8	10	10	11 1/2	8 3/4	8 3/4	39 1/2	5 3/8	32	
06	500	5 7/8	10	10	11 1/2	8 3/4	8 3/4	39 1/2	5 3/8	32	
07	675	6 7/8	12	10	11 1/2	10 3/4	8 3/4	39 1/2	5 3/8	35	
08	900	7 7/8	12	10	11 1/2	10 3/4	8 3/4	39 1/2	5 3/8	35	
09	1100	8 7/8	14	12 1/2	12 1/2	12 3/4	11 1/4	39 1/2	5 3/8	42	
10	1400	9 7/8	14	12 1/2	12 1/2	12 3/4	11 1/4	39 1/2	5 3/8	42	
12	2000	11 7/8	16	15	15	14 3/4	13 3/4	39 1/2	5 3/8	47	
14	3000	13 7/8	20	17 1/2	17 1/2	18 3/4	16 1/4	39 1/2	5 3/8	55	
16	4100	15 7/8	24	17 1/2	17 1/2	22 3/4	16 1/4	39 1/2	5 3/8	61	
24x16	7000	24x16	38	18	17 1/2	38	18	53 1/8	5 7/16	127	

Notes:

1. Control enclosure is optional on all units.
2. Weights are approximate and will vary based on selected options, insulation type, etc.
3. Control enclosures add 5 lbs. to unit weight.
4. Right hand connection shown. Electric coil connection same as control connection location.
5. NEC requires 36" clearance for electric heat enclosure.

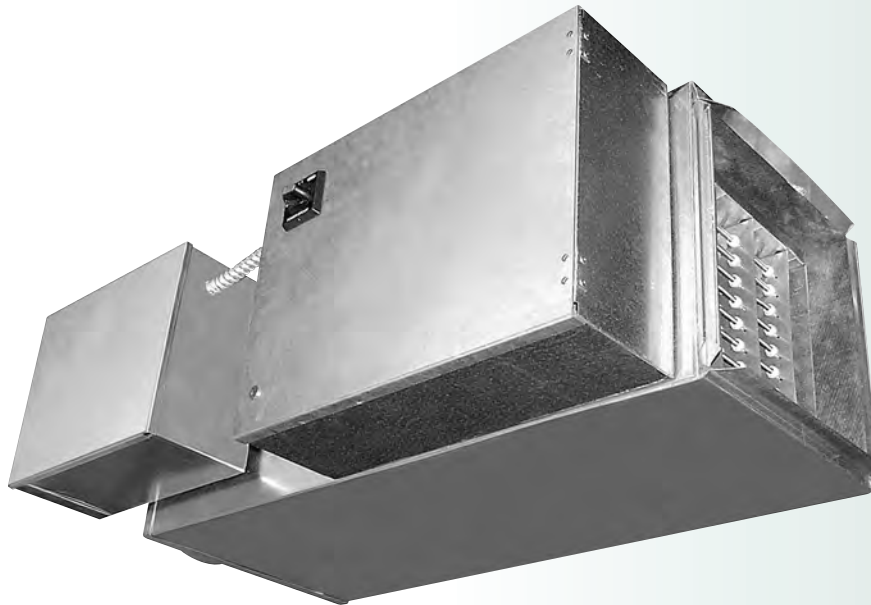

Selection

When selecting EZT single duct variable air volume terminals, several factors must be considered to make the proper selection including:

- Air Flow and Air Pressure Drop
- Sound
- Heating (if required)
- Controls

Air Flow and Air Pressure Drop

All EZT units can operate over a wide range of airflow. The minimum airflow shown for each unit is the lowest airflow at which the airflow sensor can generate an adequately strong signal for the pressure independent controls to operate properly. The maximum airflow shown for each unit is based on the industry practice of limiting the inlet air velocity to reasonable levels.

The units selected should be sized where the design airflow is between the maximum and minimum airflows shown in table 4. Referring to table 7 if 1400 CFM is the maximum design airflow, a unit with a 12 inch inlet can be selected with an air pressure drop of 0.01 inches w.g.

Sound Performance

Tables 9 thru 13, 15, 16 indicate the sound power levels of each unit at varying air flow rates and inlet static pressures. Disregarding other factors and/or equipment that could contribute to the noise in the occupied space, these ratings along

with the acoustical environment in which the unit operates, will determine the perceived noise level.

Noise generated within the terminal and emitted through the discharge air (discharge sound) will be attenuated by any ductwork downstream of the terminal. The noise emitted through the casing of the terminal (radiated sound) will be attenuated by the room's ceiling. Depending upon the application, either the radiated or discharge noise level will be the relative higher and determine the perceived noise level in the occupied space. The occupied space itself will provide further attenuation depending on the acoustical characteristics of the walls, floors and internal furnishings.

All manufacturers must make certain assumptions on the acoustical environment of the application and then apply these assumptions to the unit's sound power ratings to determine the resultant sound pressures and perceived noise level in the occupied space. While the ARI sound power ratings have been certified and can be accurately compared from one manufacturer to another, the NC values predicted will be dependent upon the acoustical assumptions made.

When selecting terminals, check the attenuation assumptions before comparing cataloged NC values. Anemostat uses the ARI Standard 885, Appendix E attenuation assumptions for determining the anticipated noise levels. The attenuation assumptions in this standard are outlined in Table 2.

Table 2: ARI-885 Attenuation Table

		Octave Band						
		2	3	4	5	6	7	
Radiated		2	1	0	0	0	0	Environmental Effect
All Sizes		16	18	20	26	31	36	Type II Mineral Fiber
		18	19	20	26	31	36	Total dB Reduction
		Octave Band						
		2	3	4	5	6	7	
Discharge		2	1	0	0	0	0	Environmental Effect
Sizes 5-7		2	4	10	20	20	14	5 ft., Duct Lining (12x12)
(300-700 cfm)		9	5	2	0	0	0	End Reflection
		6	10	18	20	21	12	5 ft., 8 in. Flex Duct
		5	6	7	8	9	10	Room Effect
		3	3	3	3	3	3	Sound Power Division
		27	29	40	51	53	39	Total dB Reduction
		Octave Band						
		2	3	4	5	6	7	
Discharge		2	1	0	0	0	0	Environmental Effect
Sizes 8-24x16		2	3	9	18	17	12	5 ft., Duct Lining (15x15)
(>700 cfm)		9	5	2	0	0	0	End Reflection
		6	10	18	20	21	12	5 ft., 8 in. Flex Duct
		5	6	7	8	9	10	Room Effect
		5	5	5	5	5	5	Sound Power Division
		29	30	41	51	52	39	Total dB Reduction

The noise level desired in any given space is a function of the activity for which the space is intended. Typical NC design values for various applications are:

Table 3: Typical NC Design Values

Hotel rooms	25 - 35
Offices and conference rooms	25 - 35
Open offices	30 - 40
Classrooms	35 - 40 (max)
Churches	25 - 35
Hospital wards	30 - 40
Gymnasiums	40 - 45
Libraries	30 - 40

The NC curves are intended to reflect a human's perceived noise comfort. Plotting the anticipated sound pressure by octave band and determining the tangent NC curve reached throughout all octave bands (using the acoustical assumptions) will indicate the NC value anticipated.

Example of NC Curve Plot

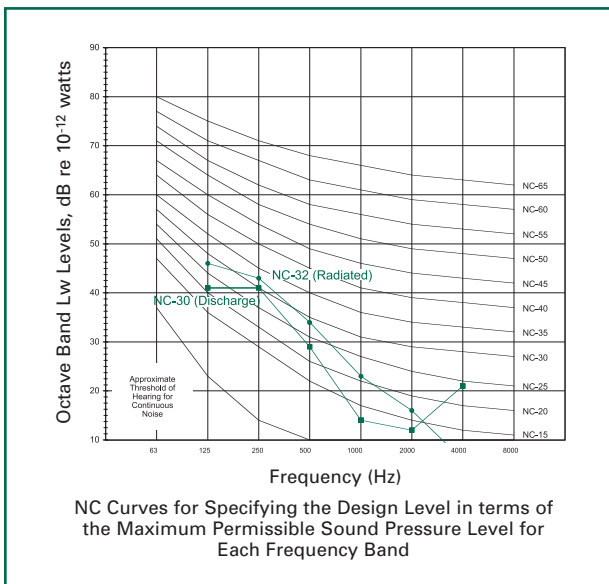

Radiated Lw – 1400 CFM @ 2.0" w.g. Inlet Ps								
	63	125	250	500	1000	2000	4000	8000
Lw Data	----	64	62	54	49	47	42	----
Attenuation	----	18	19	20	26	31	36	----
PlottedData	----	46	43	34	23	16	6	----
NC	----	27	32	29	21	17	----	----
Discharge Lw – 1400 cfm @ 2.0" w.g. Inlet Ps								
	63	125	250	500	1000	2000	4000	8000
Lw Data	----	70	71	70	65	64	60	----
Attenuation	----	29	30	41	51	52	39	----
PlottedData	----	41	41	29	14	12	21	----
NC	----	21	30	24	----	----	24	----

Notes:
Size 12 EZTS
Radiated sound in the 250 Hz (third octave) is the Controlling Band

Heating (If required)

Hot water heat – Select the hot water coil that provides at least as much heating output as required (based on the design conditions).

Using our example of a 12" size unit, if the design heating airflow is 800 CFM for the heating coil selection, the heating capacity desired is 29 Mbh, the entering water temperature is 180 degrees F and the entering air temperature is 55 degrees F, using Table 21 would indicate that a 1 row coil supplied with 4 GPM of hot water would be required.

The air pressure loss for the heating coil selected at the maximum design airflow for the terminal (1400 CFM) must be added to the EZT terminal's air pressure drop. The heating coil air pressure drops are also shown in Table 7. In our example, the air pressure drop across the coil is 0.24 inches w.g. This would be added to the terminal's air pressure drop of 0.01 inches w.g. at the design maximum airflow of 1400 CFM, which results in a total air pressure drop of 0.25 inches w.g.

Electric Heat – The wattage of electric heat needed is determined by dividing the heating required in Mbh by 3.414, which results in the KW of heating required.

Using our example, it would require 8.5 KW of electric heat to provide the 29 Mbh heating capacity. Using table 25, the electric coil with 8.5 KW would be selected. Electric heat can be staged or modulated.

Note that the electric coil has an air proving switch, which requires a minimum of .07 inch w.g. total pressure entering the coil to prove airflow.

Also note that it's prudent to check the air temperature leaving the heating coil at the design airflow. Using the previous example, the resulting leaving air temperature would be approximately 89 degrees F, which would generally provide a comfortable environment and proper air distribution.

Control Sequences

A wide array of control sequences are available as standard on Anemostat's EZT single duct variable air volume terminals. Tables 26 and 27 indicate the control sequences available as standard. Special sequences can also be provided.

Pages B-28 through B-32 describe and depict the operating performance for some of the more common control sequences.

Table 4: Airflow Ranges (Velocity Wing™ Sensor)

Type	Direct Digital		Analog Electronic		Pneumatic		Pneumatic	
Controller	Model ABC-7001,3		Model 51		Models 23, 24		Model 31	
Inlet Size	Min Airflow	Max Airflow	Min Airflow	Max Airflow	Min Airflow	Max Airflow	Min Airflow	Max Airflow
5" Ø	50	251	22	305	57	287	50	287
6" Ø	81	409	45	470	94	469	81	469
7" Ø	106	534	70	635	122	612	106	612
8" Ø	150	757	90	835	173	867	150	867
9" Ø	190	958	115	1100	220	1098	190	1098
10" Ø	234	1181	145	1355	271	1353	234	1353
12" Ø	312	1573	155	1740	360	1802	312	1802
14" Ø	428	2155	250	2300	494	2469	428	2469
16" Ø	583	2938	447	3390	673	3366	583	3366
24 x 16	1101	5550	650	6480	1272	6358	1101	6358

Notes:

- Minimum and maximum values shown are CFM
- Minimum and maximum airflow with pressure independent controls based on the following flow sensor signals:
 Model 51 Controller - 1 VDC – 10 VDC
 Model 31 Controller - 0.03" w.g. – 1.0" w.g.
 Models 23, 24 Controllers - 0.04" w.g. – 1.0" w.g.
 Models ABC-7001, 7003 Controllers - 0.03" w.g. – 0.76" w.g.
- Settings below the minimum are not recommended for accurate control when using pressure independent controls. Minimum airflow for pressure dependent applications is 0 cfm.
- Pressure independent controls may be set for 0 CFM, at or above the minimum airflow shown in table 4, but not between.
- Model 23 controller available as direct acting for normally open or model 24 controller available as reverse acting for normally closed damper positions. Factory set non-field adjustable start point and reset span.
- Model 31 controller can be used either as direct or reverse acting for normally open or normally closed damper positions. Field adjustable start point and reset span.
- Models 23, 24, 31 controllers equipped with separate adjustable knobs for maximum and minimum airflow settings.
- Model 51 electronic analog controller maximum and minimum airflow settings field adjustable at the thermostat.
- Models ABC-7001, 7003 BACnet DDC controllers are factory programmed.
- Airflow rates above maximum shown are available. Contact your Anemostat representative for application assistance.

Table 5: Airflow vs. Velocity Wing™ Signal

Sensor ΔP	Inlet Size									
	5	6	7	8	9	10	12	14	16	24x16
	CFM									
0.03	50	81	106	150	190	234	312	428	583	1101
0.04	57	94	122	173	220	271	360	494	673	1272
0.06	70	115	150	212	269	331	441	605	824	1557
0.1	91	148	194	274	347	428	570	781	1064	2011
0.2	128	210	274	388	491	605	806	1104	1505	2843
0.3	157	257	335	475	601	741	987	1352	1844	3482
0.4	182	297	387	548	694	856	1140	1562	2129	4021
0.5	203	332	433	613	776	957	1274	1746	2380	4496
0.6	222	363	474	672	851	1048	1396	1912	2607	4925
0.7	240	392	512	725	919	1132	1508	2066	2816	5319
0.8	257	419	547	775	982	1210	1612	2208	3011	5687
0.9	272	445	581	823	1042	1284	1710	2342	3193	6032
1 (K)	287	469	612	867	1098	1353	1802	2469	3366	6358
1.5	352	574	750	1062	1345	1657	2207	3024	4122	7787
Inlet Area (sq. ft.)	0.130	0.188	0.258	0.338	0.430	0.532	0.769	1.05	1.38	2.67

Airflow Calculations

Velocity Wing Sensors
 Sensor ΔP = (CFM/K)²
 CFM = K(√ΔP)

Example: For a 12" inlet unit with a sensor ΔP signal of 0.60 inches w.g., the CFM is calculated to be 1400 CFM.

CFM = K(√ΔP) = 1802(√0.60) = 1400 For a 12" inlet unit with 1400 CFM, the sensor ΔP signal is calculated to be 0.60 inches w.g. ΔP = (CFM/K)² = (1400/1802)² = 0.60" w.g.

Note: K factors shown in 1.0 ΔP row.

Graph 1: Velocity Wing Sensor Signals

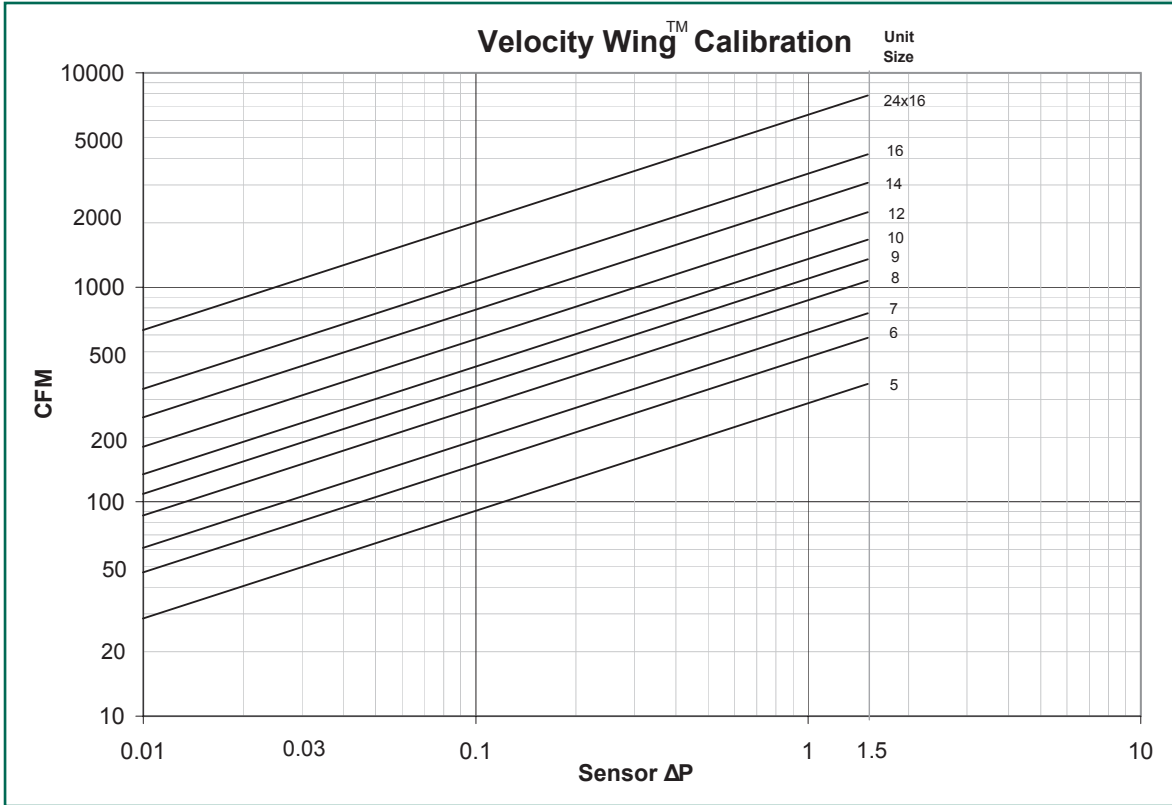

Notes:

1. The ΔP signals (High minus Low signal pressures) were determined using non-flow thru measuring equipment and therefore, pneumatic tubing diameters/lengths, and connectors will not alter these signals for non-flow thru type control devices using these pressure signals.
2. The minimum and maximum controllable air flow rates for use with DDC controls is dependent upon the controller and its design, not the inlet sensor in the air terminal. The Velocity Wing sensor will provide an accurate signal for all flow rates the controller is capable of sensing accurately.
3. Information regarding the air flow range for flow-thru type control devices should be obtained from the controls manufacturer.

Table 6: K Factors For Velocity Wing Sensor

	CFM									
	5	6	7	8	9	10	12	14	16	24x16
K-Factor	287	469	612	867	1098	1353	1802	2469	3366	6358
Area (sq. ft)	0.130	0.188	0.258	0.338	0.430	0.532	0.769	1.050	1.375	2.667

Airflow Calculations

Velocity Wing Sensors
 Sensor ΔP = (CFM/K)²
 CFM = K(√ΔP)

Example: For a 12" inlet unit with a sensor ΔP signal of 0.60 inches w.g., the CFM is calculated to be 1400 CFM.

CFM = K(√ΔP) = 1802(√0.60) = 1400 For a 12" inlet unit with 1400 CFM, the sensor ΔP signal is calculated to be 0.60 inches w.g. ΔP = (CFM/K)² = (1400/1802)² = 0.60" w.g.

Note: K factors shown in 1.0 ΔP row.

Table 7: Static Pressure Drop Data

Inlet Size	Airflow (CFM)	Min ΔPs"				
		EZTS & A	EZTE	1-row	2-row	4-row
5	125	0.05	0.05	0.025	0.030	0.065
	175	0.10	0.10	0.040	0.065	0.115
	250	0.15	0.15	0.050	0.110	0.210
	300	0.20	0.21	0.070	0.150	0.290
	350	0.25	0.26	0.100	0.190	0.380
6	200	0.01	0.01	0.040	0.070	0.140
	250	0.02	0.02	0.050	0.110	0.210
	300	0.03	0.03	0.070	0.150	0.290
	350	0.03	0.04	0.100	0.190	0.380
	400	0.04	0.05	0.120	0.240	0.480
	500	0.05	0.06	0.180	0.360	0.700
7	250	0.01	0.01	0.040	0.080	0.155
	300	0.01	0.02	0.050	0.110	0.210
	400	0.01	0.02	0.090	0.170	0.350
	500	0.02	0.03	0.130	0.260	0.520
	600	0.04	0.05	0.180	0.360	0.720
	675	0.05	0.06	0.220	0.440	0.870
8	350	0.01	0.01	0.070	0.140	0.280
	475	0.01	0.02	0.120	0.240	0.400
	600	0.01	0.02	0.180	0.360	0.720
	700	0.01	0.03	0.240	0.470	0.940
	800	0.01	0.04	0.300	0.600	1.200
	900	0.01	0.04	0.370	0.740	1.480
9	450	0.01	0.01	0.060	0.120	0.250
	525	0.01	0.02	0.075	0.150	0.300
	600	0.01	0.02	0.095	0.200	0.390
	700	0.01	0.03	0.120	0.250	0.490
	900	0.01	0.04	0.190	0.380	0.750
	1100	0.01	0.05	0.260	0.520	1.050

Inlet Size	Airflow (CFM)	Min ΔPs"				
		EZTS & A	EZTE	1-row	2-row	4-row
10	550	0.01	0.01	0.080	0.160	0.320
	675	0.01	0.02	0.110	0.230	0.450
	800	0.01	0.02	0.150	0.310	0.610
	1000	0.01	0.03	0.230	0.460	0.900
	1200	0.01	0.04	0.310	0.630	1.260
	1400	0.01	0.06	0.420	0.850	1.700
12	800	0.01	0.01	0.090	0.170	0.350
	1000	0.01	0.02	0.130	0.260	0.520
	1200	0.01	0.02	0.180	0.360	0.720
	1400	0.01	0.03	0.240	0.470	0.940
	1700	0.01	0.05	0.335	0.670	1.340
	2000	0.01	0.06	0.450	1.190	1.780
14	1050	0.01	0.01	0.075	0.150	0.300
	1400	0.01	0.02	0.120	0.240	0.480
	1800	0.01	0.02	0.190	0.380	0.760
	2200	0.01	0.03	0.270	0.530	1.080
	2600	0.01	0.04	0.360	0.730	1.450
	3000	0.01	0.05	0.470	0.930	1.860
16	1400	0.01	0.01	0.085	0.180	0.350
	1900	0.01	0.01	0.160	0.300	0.600
	2400	0.01	0.02	0.230	0.460	0.910
	2900	0.01	0.02	0.320	0.640	1.280
	3500	0.01	0.03	0.440	0.890	1.780
	4100	0.01	0.04	0.590	1.180	2.360
24x16	3000	0.01	0.01	0.150	0.300	0.600
	4000	0.01	0.02	0.250	0.500	1.000
	5000	0.01	0.03	0.373	0.750	1.480
	6000	0.01	0.04	0.510	1.025	2.057
	7000	0.01	0.05	0.680	1.350	2.710

Notes:

1. Air pressure drops shown for EZTE units with electric coil are for the terminal and electric coil.
2. Air pressure drops shown for the hot water coils must be added to the terminal air pressure drop.
3. Air pressure drop is the difference in static pressure from the terminal inlet and discharge with the damper in the fully open position.

Table 8: ARI Certified Ratings - EZTS units

Inlet Size	Airflow (CFM)	Min Ps (in. w.g.)	Radiated Sound Power (dB) by octave band @ 1.5" w.g.							Discharge Sound Power (dB) by octave band @ 1.5" w.g.						
			2	3	4	5	6	7	2	3	4	5	6	7		
5	250	0.18	59	55	49	45	42	34	70	67	61	57	54	51		
6	400	0.10	60	57	50	43	44	40	73	72	65	62	59	55		
7	550	0.10	62	64	58	52	47	41	71	73	64	61	58	56		
8	700	0.01	60	59	52	46	44	42	74	73	66	64	61	57		
9	900	0.01	60	59	53	48	47	42	73	72	63	61	60	58		
10	1100	0.01	60	59	52	49	48	43	71	72	66	65	62	59		
12	1600	0.01	64	60	53	49	48	42	74	72	67	65	63	59		
14	2100	0.01	64	61	52	49	48	44	74	70	67	65	64	62		
16	2800	0.01	66	62	53	51	50	46	75	71	67	65	64	62		
24x16	5300	0.01	78	71	65	59	55	49	81	79	74	73	72	69		

Notes:

1. All sound data are measured in accordance with industry standard ARI-880
2. Sound power levels are in decibels, re 10⁻¹² watts
3. Discharge Lw includes end reflection loss per AHRI requirement



Table 9: Radiated Sound Power Data (dB) – EZTS units

Inlet Size	Airflow (CFM)	0.5" ΔPs						1.0" ΔPs						2.0" ΔPs						3.0" ΔPs					
		Sound Power Levels, dB						Sound Power Levels, dB						Sound Power Levels, dB						Sound Power Levels, dB					
		Octave Band						Octave Band						Octave Band						Octave Band					
		2	3	4	5	6	7	2	3	4	5	6	7	2	3	4	5	6	7	2	3	4	5	6	7
5	125	46	41	33	30	27	24	51	43	39	34	33	27	50	46	43	39	38	33	50	47	44	42	42	37
	175	49	44	35	31	28	25	52	48	41	37	35	28	54	51	47	42	40	34	54	52	49	45	44	38
	250	52	47	39	33	30	26	55	51	44	38	36	29	58	56	50	45	43	35	58	58	53	48	46	39
	300	53	49	41	35	32	27	56	53	46	40	37	30	60	57	52	46	44	36	60	60	55	50	48	40
	350	54	50	44	37	34	32	58	55	48	41	39	34	62	58	54	47	45	38	62	61	58	51	49	41
6	200	49	42	35	29	28	27	52	47	40	34	34	31	52	49	46	39	40	37	53	50	48	42	43	40
	250	50	43	36	30	30	28	53	48	41	35	35	32	55	53	48	41	41	38	55	53	51	44	44	41
	300	51	44	37	31	31	29	54	49	42	36	36	33	57	55	49	42	42	39	57	56	53	46	45	42
	350	52	45	39	32	32	30	55	50	43	37	37	34	58	56	50	43	43	40	59	59	55	48	46	43
	400	53	46	41	34	33	31	56	51	44	38	38	35	60	57	51	44	44	41	60	61	56	49	47	44
	500	56	50	45	38	37	35	58	53	48	40	40	38	62	58	53	46	45	42	63	62	57	50	49	45
7	250	50	46	38	33	30	26	52	51	44	39	36	31	52	52	48	43	41	36	52	53	49	46	44	41
	300	51	47	39	35	31	27	53	55	46	40	37	32	53	55	50	45	43	38	54	56	52	48	45	42
	400	52	48	40	36	33	28	56	56	48	42	39	33	56	62	54	49	45	40	57	61	56	51	48	43
	500	55	49	42	38	34	30	57	57	49	43	40	34	59	65	58	52	47	41	59	66	60	55	50	45
	600	58	50	45	40	36	31	60	58	50	44	41	35	61	66	59	53	48	42	61	69	63	58	52	46
	675	59	51	47	42	38	32	61	59	51	45	42	36	64	67	60	54	49	43	63	70	65	60	53	47
	8	350	49	44	36	31	29	29	53	50	43	38	36	34	54	55	50	45	43	40	55	55	52	48	47
475		50	45	37	33	32	30	54	51	44	39	37	35	56	60	51	46	44	41	57	60	56	51	48	44
600		51	46	39	35	33	31	55	52	45	40	38	36	58	61	52	47	45	41	59	64	58	52	49	45
700		53	47	41	37	36	32	56	53	46	41	39	37	60	62	53	48	45	42	60	65	59	53	50	46
800		54	49	44	40	38	33	57	54	47	43	41	38	61	63	54	49	46	43	62	66	60	54	50	47
900		56	50	47	43	40	35	59	55	49	45	43	39	63	64	55	50	47	44	63	67	61	55	51	47
9	450	47	44	37	33	31	26	51	52	43	38	36	31	55	58	51	45	43	38	57	63	55	49	47	42
	525	48	45	38	34	32	27	52	53	44	39	37	32	57	59	52	46	44	39	58	66	57	50	48	43
	600	49	46	39	35	33	28	53	54	45	40	38	33	58	60	53	47	45	40	59	67	58	51	49	44
	700	53	49	41	36	34	29	54	55	46	41	39	34	59	61	54	48	46	41	60	68	59	52	50	45
	900	55	54	45	39	36	31	55	56	48	43	40	35	60	62	55	49	47	42	61	69	60	53	51	46
	1100	56	55	48	42	38	33	56	57	50	44	41	36	61	63	56	50	48	44	63	70	61	54	52	47
	10	550	49	43	38	34	33	28	52	51	43	40	39	35	54	57	50	46	45	40	55	61	53	51	48
675		50	44	40	36	34	29	53	52	44	41	40	36	56	58	51	47	46	41	56	62	54	51	49	44
800		51	46	41	37	35	30	54	53	45	42	41	37	57	59	52	48	47	42	58	63	55	52	50	45
1000		52	48	44	39	37	31	55	54	47	43	42	38	59	60	53	49	48	43	60	64	56	53	51	46
1200		55	51	46	41	39	34	57	55	49	45	43	39	61	61	54	50	49	44	62	65	57	53	52	47
1400		57	53	49	44	41	36	59	56	52	48	46	40	63	62	55	51	50	45	64	66	58	54	53	48
12	800	51	44	37	34	33	27	56	50	43	39	39	33	60	59	51	46	44	39	60	60	57	50	48	43
	1000	52	45	38	35	34	29	57	51	44	40	40	34	62	60	52	47	45	40	62	62	58	51	49	44
	1200	53	47	40	37	35	30	58	52	45	41	41	35	63	61	53	48	46	41	64	63	59	52	50	45
	1400	54	48	42	39	36	31	59	53	46	43	42	36	64	62	54	49	47	42	66	64	59	53	51	46
	1700	56	51	45	42	39	32	60	55	48	45	43	37	65	63	55	50	48	43	68	65	60	54	52	47
	2000	58	53	49	45	42	35	62	57	51	47	45	38	67	64	56	51	49	44	69	66	60	55	53	48
14	1050	51	44	36	35	34	30	57	52	42	39	39	36	61	60	51	47	45	42	61	63	55	50	49	45
	1400	52	45	39	36	36	31	58	53	43	40	40	37	63	61	52	48	46	43	64	64	56	51	50	46
	1800	54	48	41	38	37	32	59	54	45	43	42	38	64	62	53	49	47	44	66	65	57	52	51	47
	2200	56	51	45	41	39	35	60	55	47	44	44	39	65	63	54	50	49	45	67	66	58	53	52	48
	2600	59	54	48	44	42	37	62	57	50	46	45	41	66	64	55	51	50	46	69	67	59	54	53	49
	3000	61	56	51	47	45	40	64	59	53	49	47	43	68	64	56	52	52	47	70	68	60	55	54	50
16	1400	50	45	38	36	37	32	57	53	44	41	40	37	61	61	51	48	46	42	63	64	55	51	50	46
	1900	52	47	40	38	38	33	58	54	45	42	41	38	64	62	52	49	47	43	65	64	56	52	51	47
	2400	55	50	43	41	40	36	60	55	46	45	44	39	65	63	53	50	48	44	67	65	57	53	52	48
	2900	58	52	45	43	41	38	62	57	48	46	46	41	67	64	54	51	50	46	69	67	58	54	53	49
	3500	61	55	48	45	43	40	64	59	51	48	47	42	68	65	55	52	51	47	70	68	59	55	54	50
	4100	64	58	52	48	45	42	66	61	54	50	49	44	69	66	56	53	52	48	71	69	60	56	55	51
24x16	3000	61	54	49	44	40	35	65	57	52	48	44	38	71	64	58	53	50	44	73	68	63	57	53	48
	4000	66	59	55	48	44	38	69	62	56	51	46	41	74	67	60	55	51	45	76	70	64	58	54	49
	5000	70	63	59	53	48	41	73	65	60	54	51	45	77	69	63	58	53	47	79	72	65	59	56	50
	6000	73	67	63	56	51	44	75	69	63	56	52	47	79	70	64	59	54	48	81	73	66	60	57	51
	7000	76	70	66	59	54	46	78	71	66	58	54	50	81	72	66	60	55	49	83	74	67	61	58	52

Notes:

1. All sound data are measured in accordance with industry standard ARI-880
2. Sound power levels are in decibels, re 10⁻¹² watts

Table 10: Discharge Sound Power Data (dB) – EZTS units
Matte Faced Insulation

Inlet Size	Airflow (CFM)	0.5" ΔPs						1.0" ΔPs						2.0" ΔPs						3.0" ΔPs					
		Sound Power Levels, dB						Sound Power Levels, dB						Sound Power Levels, dB						Sound Power Levels, dB					
		Octave Band						Octave Band						Octave Band						Octave Band					
		2	3	4	5	6	7	2	3	4	5	6	7	2	3	4	5	6	7	2	3	4	5	6	7
5	125	57	52	44	41	37	33	59	56	50	46	44	42	59	57	54	51	52	50	59	58	56	53	55	55
	175	59	56	47	43	39	35	62	60	52	49	46	43	64	64	58	54	53	51	64	64	60	57	56	56
	250	62	59	51	47	42	38	65	63	55	51	48	45	69	67	61	57	54	52	69	69	64	61	58	57
	300	63	60	53	49	45	41	66	65	58	53	49	46	71	69	63	59	55	53	72	71	66	62	59	58
	350	64	61	55	53	49	45	69	66	60	55	51	48	72	70	65	60	56	55	74	72	68	63	60	59
6	200	59	56	47	46	42	36	63	62	54	51	48	44	64	63	60	56	54	52	64	64	61	59	57	56
	250	60	58	49	47	43	39	65	65	55	53	50	46	68	68	63	59	56	53	68	68	64	62	59	57
	300	61	60	51	49	44	40	66	66	56	54	51	47	69	71	64	60	58	54	70	72	67	64	61	58
	350	63	62	53	51	45	41	67	67	57	55	52	48	71	72	65	62	59	55	72	75	69	66	63	59
	400	65	64	56	53	46	43	68	68	59	57	53	49	72	73	66	63	60	56	73	77	71	67	64	60
500	68	66	59	58	48	46	71	70	63	60	54	51	75	76	68	65	61	57	76	79	72	68	66	61	
7	250	59	55	47	45	41	38	62	60	54	50	48	46	64	63	61	56	54	53	65	63	62	60	58	57
	300	60	56	48	46	42	39	64	62	55	51	49	47	67	66	62	58	55	54	67	66	64	61	59	58
	400	61	59	50	49	43	41	65	65	56	54	50	49	69	70	64	60	57	56	70	71	67	64	61	60
	500	62	61	53	52	45	43	66	66	57	55	51	50	70	72	65	62	58	57	72	74	69	66	62	61
	600	64	62	56	55	47	45	67	67	60	58	52	51	72	73	66	63	59	58	74	76	70	67	63	62
675	67	64	59	58	48	46	69	68	63	60	54	52	73	74	67	64	60	58	75	77	71	68	64	63	
8	350	61	56	48	47	45	40	66	64	56	54	51	47	67	69	63	61	58	55	68	69	67	65	62	58
	475	62	58	50	49	46	41	67	65	57	55	53	48	71	71	64	62	59	56	72	74	69	67	63	59
	600	63	60	52	52	48	43	68	66	58	57	54	49	72	74	65	63	60	57	73	78	71	68	65	60
	700	64	62	54	54	49	44	69	67	59	58	55	50	73	75	66	64	61	58	74	79	72	69	66	61
	800	66	64	57	57	50	46	70	68	61	60	56	51	74	76	67	65	62	58	76	80	73	70	67	62
900	68	65	60	59	52	48	71	69	62	61	57	52	75	77	68	66	63	59	77	81	74	71	68	63	
9	450	58	53	47	46	44	40	64	62	53	51	50	48	68	68	61	58	56	55	69	69	66	63	60	59
	525	59	54	48	47	45	41	65	63	54	52	51	49	69	70	62	59	57	56	71	71	67	64	61	60
	600	60	56	49	48	47	42	66	64	55	53	52	50	71	71	63	60	58	57	72	72	68	65	62	61
	700	61	58	50	49	48	43	67	65	56	54	53	51	72	72	64	61	59	58	73	75	69	66	63	62
	900	62	60	52	51	49	44	68	66	57	56	54	52	73	73	65	62	60	59	75	76	70	67	64	63
1100	66	63	58	57	50	47	69	67	60	59	55	53	74	74	66	64	62	60	77	78	71	68	66	65	
10	550	57	56	49	48	46	41	62	64	56	54	53	50	67	71	65	62	60	57	68	75	69	66	64	61
	675	58	57	50	49	47	42	63	65	57	55	54	51	69	72	66	63	61	58	70	76	70	67	65	62
	800	60	59	52	50	48	43	64	66	58	57	55	52	70	73	67	64	62	59	71	77	71	68	66	63
	1000	61	63	54	53	50	46	65	67	59	58	56	53	71	74	68	65	63	60	73	78	72	69	67	64
	1200	63	66	57	56	52	49	66	69	61	60	57	54	72	75	69	66	64	61	74	79	73	70	68	65
1400	65	67	60	59	53	51	68	70	63	62	59	55	73	76	70	67	65	62	75	80	73	71	69	66	
12	800	59	55	50	48	47	41	65	61	57	55	53	50	72	70	68	62	61	57	73	74	70	67	65	62
	1000	60	56	52	49	48	43	66	62	58	56	54	51	73	71	69	63	62	58	75	75	71	68	66	63
	1200	61	58	54	51	49	44	67	64	59	57	55	52	74	72	70	64	63	59	76	76	72	69	67	64
	1400	62	60	56	53	50	46	68	65	60	58	56	53	75	73	71	65	64	60	77	77	73	70	68	64
	1700	64	62	59	56	52	48	69	66	62	60	58	54	76	74	72	66	65	61	78	78	74	71	69	65
2000	67	64	62	58	54	51	71	68	65	62	59	56	77	75	73	67	66	62	79	79	75	72	70	66	
14	1050	58	53	50	50	49	46	66	62	57	56	55	54	71	69	65	63	61	59	72	73	69	67	66	63
	1400	60	55	52	51	50	47	67	63	58	57	56	55	72	70	66	64	62	60	76	74	70	68	67	64
	1800	63	57	55	54	51	48	68	64	60	58	57	56	73	71	67	65	63	61	76	75	71	69	68	65
	2200	65	60	57	55	52	49	69	65	61	60	58	57	74	72	68	66	64	62	77	76	72	70	69	66
	2600	67	62	61	57	55	51	71	67	63	61	59	57	76	73	69	67	66	64	78	77	73	71	70	67
3000	69	65	64	60	57	54	73	69	66	62	61	58	77	74	70	68	67	65	80	78	74	72	71	68	
16	1400	59	53	51	51	49	45	65	61	57	55	56	54	72	69	65	62	61	60	73	73	70	66	65	64
	1900	61	55	53	53	50	46	67	62	58	57	57	55	73	70	66	63	62	61	75	74	71	67	66	65
	2400	64	58	55	54	52	48	68	64	60	59	58	56	74	71	67	64	63	62	77	75	72	68	67	66
	2900	67	61	58	56	53	50	71	66	62	60	59	57	76	72	68	66	65	63	79	76	73	69	68	67
	3500	71	64	62	59	56	53	74	68	65	62	61	58	78	73	70	67	66	64	81	77	74	70	70	68
4100	73	67	67	61	58	55	76	70	68	64	62	59	80	75	72	68	68	65	82	79	75	72	71	69	
24x16	3000	64	62	59	58	54	50	68	67	63	62	61	58	75	73	68	67	67	65	78	77	72	71	71	69
	4000	69	67	63	60	58	54	72	70	66	65	63	60	77	75	70	70	69	67	81	79	74	73	73	71
	5000	73	72	68	65	62	59	76	74	69	68	66	63	80	78	73	72	71	68	84	81	76	75	75	72
	6000	78	77	72	69	67	64	80	78	73	70	69	66	83	81	76	74	73	70	87	83	78	76	76	74
	7000	81	79	75	71	69	67	82	80	75	72	70	67	84	82	77	76	74	71	88	84	79	77	77	75

Notes:

1. All sound data are measured in accordance with industry standard ARI-880
2. Sound power levels are in decibels, re 10⁻¹² watts

**Table 11: Discharge Sound Power Data (dB) – EZTS units
Matte Faced Insulation with 1 or 2 Row Hot Water Coil**

Inlet Size	Airflow (CFM)	0.5" ΔPs						1.0" ΔPs						2.0" ΔPs						3.0" ΔPs					
		Sound Power Levels, dB						Sound Power Levels, dB						Sound Power Levels, dB						Sound Power Levels, dB					
		Octave Band						Octave Band						Octave Band						Octave Band					
		2	3	4	5	6	7	2	3	4	5	6	7	2	3	4	5	6	7	2	3	4	5	6	7
5	125	60	57	46	46	44	42	63	61	53	52	53	51	63	62	57	58	61	60	64	63	60	60	64	64
	175	63	60	49	47	45	44	66	66	55	55	54	52	67	68	61	61	62	61	69	70	64	64	66	65
	250	65	63	53	52	47	46	70	68	58	57	55	53	73	73	65	63	63	62	74	75	68	68	68	66
	300	66	65	55	53	51	48	71	71	60	58	56	54	75	75	67	65	64	63	76	77	71	69	69	67
	350	67	66	56	55	54	50	74	73	62	59	57	55	76	77	68	66	65	64	78	79	72	70	71	68
6	200	61	60	49	51	48	45	65	66	57	57	58	53	68	69	63	62	62	60	69	70	66	65	64	63
	250	63	63	51	52	49	47	69	71	58	59	59	54	71	73	66	66	66	61	73	73	69	68	69	66
	300	65	64	53	53	50	48	70	72	59	60	60	55	72	75	67	67	67	62	75	78	70	71	71	68
	350	67	66	55	55	51	49	72	73	61	61	61	56	75	78	68	68	68	63	77	81	74	73	72	69
	400	68	69	58	57	52	50	73	74	62	62	61	57	77	79	69	69	69	65	78	83	75	74	74	70
	500	71	71	60	60	54	51	76	77	66	64	61	58	79	83	71	70	70	66	80	86	76	75	76	71
7	250	61	60	51	50	47	46	66	65	59	57	56	56	68	67	66	63	63	63	70	69	67	67	67	67
	300	65	61	52	51	48	47	69	67	61	58	57	57	74	71	69	66	65	64	74	72	71	70	70	69
	400	66	64	54	54	49	48	70	70	62	61	58	58	75	74	70	68	66	65	77	78	74	72	71	70
	500	67	66	56	56	50	49	71	71	63	62	59	59	78	77	72	70	67	66	79	79	75	74	72	71
	600	69	67	60	59	51	50	72	74	66	64	60	59	79	79	73	71	68	67	82	82	77	76	73	72
	675	70	69	61	61	53	52	74	75	67	66	60	59	80	80	74	72	69	68	83	84	78	77	74	73
8	350	63	61	52	52	52	48	70	68	61	61	61	58	71	73	68	68	67	65	73	75	72	71	72	68
	475	66	63	55	53	53	49	71	70	62	63	62	58	76	75	70	69	69	66	77	79	75	74	73	69
	600	68	65	56	57	54	51	72	71	63	64	63	58	78	79	72	70	70	67	80	84	78	76	75	71
	700	69	67	58	58	55	51	73	72	65	65	63	59	81	80	73	71	71	68	81	85	79	77	76	71
	800	70	69	61	61	56	53	74	75	66	66	63	60	82	82	74	72	72	68	83	86	80	79	77	72
	900	71	70	62	63	57	54	75	76	67	67	63	60	82	84	75	74	73	69	84	88	82	80	78	73
9	450	65	58	51	51	49	46	70	66	59	58	59	57	74	72	67	67	67	66	74	74	72	71	71	71
	525	66	59	52	52	50	47	71	68	60	58	59	58	74	75	69	68	68	67	76	77	73	72	72	71
	600	67	60	53	53	52	48	72	69	61	58	59	58	76	77	70	69	68	67	78	79	74	73	73	72
	700	68	61	55	54	53	49	73	70	62	59	59	58	78	78	72	69	68	67	79	81	77	74	73	72
	900	69	62	57	55	54	51	74	71	63	60	60	59	79	78	73	69	68	68	80	82	79	76	74	73
	1100	72	67	63	61	55	54	75	72	66	63	60	60	79	79	74	70	69	69	82	83	80	76	75	74
10	550	64	61	54	52	51	48	67	68	62	60	62	59	73	75	71	71	71	68	73	81	75	75	75	73
	675	65	62	55	53	52	49	68	70	63	61	62	60	74	77	73	72	72	69	75	82	76	75	76	73
	800	66	63	56	54	53	50	70	72	64	62	62	60	75	78	74	73	72	69	77	83	77	76	77	74
	1000	67	66	59	56	55	52	71	73	65	63	62	60	77	79	76	73	72	69	79	84	80	77	78	74
	1200	69	68	62	59	57	56	73	74	67	65	63	61	78	80	77	73	72	70	79	85	81	78	78	75
	1400	71	71	65	62	59	57	74	75	69	66	64	63	78	81	78	73	72	70	80	85	82	79	78	75
12	800	64	60	56	52	52	49	69	64	62	61	59	57	77	72	73	68	69	65	78	77	75	73	74	73
	1000	66	61	57	53	53	50	70	67	63	62	60	58	78	74	75	69	70	66	79	78	76	74	75	73
	1200	67	62	58	54	54	52	73	71	64	64	62	59	79	77	78	72	71	67	80	80	79	76	76	73
	1400	68	64	60	56	55	54	74	72	65	65	63	60	80	78	79	73	72	68	81	81	80	77	77	73
	1700	69	65	63	59	57	55	75	73	67	66	64	62	81	80	80	75	73	69	82	82	82	79	78	75
	2000	71	68	66	62	60	58	77	74	70	67	65	64	82	81	81	76	74	71	83	83	84	81	79	76
14	1050	65	59	55	54	53	54	72	68	63	61	61	61	78	74	71	70	69	67	78	79	74	74	74	72
	1400	66	61	56	55	56	55	73	69	65	64	63	62	78	76	72	71	71	68	79	80	76	75	76	73
	1800	67	63	59	58	57	56	74	71	66	65	64	63	78	77	73	72	72	70	80	81	78	77	77	74
	2200	68	64	62	59	59	58	76	72	67	66	65	64	78	78	74	73	73	71	81	81	81	78	78	75
	2600	70	65	65	62	60	60	76	73	69	66	65	65	79	79	75	74	74	72	82	82	82	79	79	76
	3000	72	67	69	65	63	62	77	74	71	67	67	66	81	82	80	75	75	73	84	86	85	80	80	77
16	1400	65	59	55	55	53	51	70	67	63	63	64	61	78	74	70	69	70	69	79	78	77	74	75	73
	1900	66	60	56	56	54	52	71	68	64	64	64	62	79	76	71	70	71	70	81	79	78	76	76	73
	2400	68	61	60	58	57	55	72	69	66	66	65	63	81	78	73	71	72	71	82	79	79	77	77	74
	2900	72	64	62	60	58	56	73	70	68	66	65	65	81	79	75	73	73	71	83	80	80	78	77	75
	3500	75	67	66	63	61	59	74	71	70	68	67	66	81	79	78	75	74	72	84	81	82	79	78	76
	4100	77	70	71	64	62	61	77	72	73	69	68	67	81	79	80	76	75	73	84	82	83	80	79	77

Notes:
 1. All sound data are measured in accordance with industry standard ARI-880
 2. Sound power levels are in decibels, re 10⁻¹² watts

Table 12: Discharge Sound Power Data (dB) – EZTS units
Foil Faced Insulation

Inlet Size	Airflow (CFM)	0.5" ΔPs						1.0" ΔPs						2.0" ΔPs						3.0" ΔPs					
		Sound Power Levels, dB						Sound Power Levels, dB						Sound Power Levels, dB						Sound Power Levels, dB					
		Octave Band						Octave Band						Octave Band						Octave Band					
		2	3	4	5	6	7	2	3	4	5	6	7	2	3	4	5	6	7	2	3	4	5	6	7
5	125	57	53	45	42	40	38	60	56	52	49	48	48	60	61	57	56	55	57	59	61	59	57	59	60
	175	59	57	48	44	42	39	62	60	53	51	49	49	65	66	60	57	55	57	64	68	64	60	60	61
	250	62	59	51	48	45	42	65	63	56	53	50	50	69	68	62	58	56	58	69	72	66	61	60	62
	300	63	60	53	49	47	44	66	65	58	54	51	51	71	69	63	59	56	58	72	72	67	62	60	63
	350	64	61	55	53	49	47	69	66	60	56	53	53	72	70	65	59	56	60	74	72	68	63	60	63
6	200	59	56	48	48	45	41	64	63	55	54	52	51	65	68	62	59	58	58	64	67	64	63	60	61
	250	60	59	50	49	46	42	65	65	56	55	53	52	68	71	63	60	59	59	68	73	68	64	61	62
	300	61	61	51	50	46	43	66	67	57	56	54	53	69	72	64	61	60	60	70	75	69	65	62	63
	350	63	62	52	51	47	44	67	68	58	57	55	53	71	73	65	62	60	60	72	76	70	66	63	64
	400	65	64	56	53	47	46	68	69	60	58	55	54	72	74	66	63	60	60	73	77	71	67	64	64
	500	68	66	59	58	49	49	71	70	63	60	55	54	75	76	68	64	61	61	76	79	72	68	66	65
7	250	59	52	46	46	43	42	62	60	54	51	50	51	64	64	63	58	56	57	65	67	63	62	60	62
	300	60	56	48	47	44	45	64	62	55	52	50	53	67	66	63	59	58	58	67	68	65	63	61	63
	400	61	59	50	49	45	46	65	65	56	54	50	54	69	70	64	60	59	59	70	71	67	64	62	66
	500	62	61	53	51	47	49	66	66	57	55	52	55	70	72	65	61	59	60	72	74	69	65	62	66
	600	64	62	57	55	48	50	67	67	60	58	53	56	72	73	66	63	59	61	74	76	70	67	63	66
	675	67	64	60	58	49	51	69	68	63	60	54	57	73	74	67	64	59	62	75	77	71	68	64	66
8	350	61	56	48	49	47	45	65	64	56	55	53	52	67	70	65	63	60	59	68	73	68	67	64	63
	475	62	57	50	50	48	47	67	65	57	56	54	53	71	71	65	63	61	60	72	75	70	68	65	64
	600	63	60	52	52	49	48	68	66	58	57	55	54	72	74	65	63	62	61	73	78	71	69	66	66
	700	64	62	55	54	51	50	69	67	59	58	56	55	73	75	66	64	62	62	74	79	72	69	66	66
	800	66	64	57	57	52	51	70	68	61	60	57	56	74	76	67	65	63	62	76	80	73	70	67	66
	900	68	65	61	59	53	52	71	69	63	61	58	57	75	77	68	66	63	62	77	81	74	71	68	66
9	450	58	54	48	47	46	44	64	62	55	53	52	53	67	71	63	62	60	60	69	70	69	66	64	65
	525	59	56	49	49	47	45	65	63	56	54	53	54	69	71	64	62	60	61	71	72	69	67	64	66
	600	60	57	50	50	48	46	66	64	57	55	54	55	71	72	64	62	61	62	72	74	70	68	65	66
	700	61	58	51	51	49	47	67	65	58	56	55	55	72	72	64	62	61	62	73	75	70	68	65	66
	900	62	60	54	52	50	48	68	66	59	57	56	56	73	73	65	62	62	62	75	76	71	69	66	67
	1100	66	63	59	58	51	49	68	67	62	59	57	56	74	74	66	65	63	64	77	78	72	69	67	69
10	550	56	57	50	50	49	46	62	64	59	56	55	55	67	74	67	67	64	62	68	76	72	69	68	67
	675	58	59	51	51	50	47	63	65	60	57	56	56	69	74	68	66	64	63	70	77	72	70	68	68
	800	60	60	53	52	51	48	64	66	61	58	57	57	70	74	68	66	65	64	71	78	73	71	69	68
	1000	61	63	55	55	52	49	65	67	62	60	58	57	71	74	68	66	65	64	73	78	73	71	69	68
	1200	63	66	58	57	53	50	66	69	63	61	59	58	72	75	69	67	66	65	74	79	73	71	70	69
	1400	65	67	61	59	55	53	67	70	65	62	60	58	73	76	70	68	66	65	75	80	74	72	70	70
12	800	59	56	51	52	49	48	65	62	59	57	55	56	73	72	68	65	66	64	74	75	73	70	67	68
	1000	60	57	53	53	50	48	66	63	60	58	56	57	75	73	69	65	66	64	75	76	73	70	68	68
	1200	61	58	55	54	51	49	67	66	61	59	57	57	76	74	70	65	66	64	76	77	74	70	69	69
	1400	62	60	56	55	53	50	69	67	62	60	58	58	77	75	71	66	67	65	77	78	74	70	70	69
	1700	65	62	60	56	54	52	71	68	65	62	59	59	78	76	72	68	68	66	78	79	74	71	71	70
	2000	67	64	63	58	56	53	72	70	66	63	60	60	78	75	73	69	69	66	79	80	75	73	72	71
14	1050	59	54	52	53	51	48	67	63	60	57	56	57	72	71	67	65	64	64	74	74	72	69	67	69
	1400	61	56	54	54	52	49	68	64	61	58	57	58	73	72	68	66	65	65	75	75	73	70	68	70
	1800	64	59	56	55	53	50	69	65	62	59	58	59	74	73	69	67	66	65	76	76	74	71	69	70
	2200	67	63	60	57	54	53	70	66	65	60	59	60	76	74	70	68	67	67	77	77	75	72	70	71
	2600	70	66	63	59	56	55	71	67	67	61	60	61	77	73	71	69	68	68	78	78	76	73	71	72
	3000	72	68	66	62	58	57	74	70	69	63	62	62	78	74	72	70	69	69	80	79	77	74	72	70
16	1400	59	53	51	52	50	49	65	61	58	57	56	59	72	69	67	63	63	65	73	74	71	68	67	70
	1900	61	55	54	53	51	50	67	62	60	58	58	60	73	70	68	64	64	66	75	75	73	69	68	70
	2400	64	58	56	54	53	51	68	64	61	59	59	61	74	71	69	65	65	66	77	76	74	70	69	71
	2900	67	61	59	56	54	52	71	65	63	61	60	62	76	72	70	66	66	67	79	77	74	70	70	72
	3500	71	64	63	59	56	55	74	68	66	62	61	63	78	73	71	67	66	68	81	78	75	71	70	73
	4100	73	67	69	61	59	58	76	70	70	64	62	64	80	75	73	69	68	69	82	79	76	72	71	73

Notes:

1. All sound data are measured in accordance with industry standard ARI-880
2. Sound power levels are in decibels, re 10⁻¹² watts

Table 13: Discharge Sound Power Data (dB) – EZTS units
Dual Wall Metal Liner

Inlet Size	Airflow (CFM)	0.5" ΔPs						1.0" ΔPs						2.0" ΔPs						3.0" ΔPs					
		Sound Power Levels, dB						Sound Power Levels, dB						Sound Power Levels, dB						Sound Power Levels, dB					
		Octave Band						Octave Band						Octave Band						Octave Band					
		2	3	4	5	6	7	2	3	4	5	6	7	2	3	4	5	6	7	2	3	4	5	6	7
5	125	57	52	45	42	40	36	59	56	50	47	46	45	59	57	54	53	55	53	59	58	56	56	59	59
	175	59	56	48	45	42	39	62	60	54	51	48	46	64	64	58	55	55	54	64	64	60	59	60	59
	250	62	59	52	49	46	43	65	63	56	53	50	48	69	67	61	58	56	55	69	69	64	60	60	60
	300	63	60	53	51	49	45	66	65	59	55	51	49	71	69	63	59	56	56	72	71	66	62	60	61
	350	64	61	56	54	54	51	69	66	60	56	54	53	72	70	65	61	58	59	74	72	68	64	61	62
6	200	59	56	48	47	44	41	63	61	54	53	51	48	64	63	60	59	58	55	64	64	61	62	61	59
	250	60	58	50	49	46	42	65	65	55	54	52	49	68	68	63	60	59	56	68	68	64	64	62	60
	300	61	60	52	51	47	43	66	66	57	56	54	50	69	71	64	61	60	57	70	72	67	65	63	61
	350	63	62	53	53	49	45	67	67	59	57	55	51	71	72	65	62	61	58	72	75	69	66	64	62
	400	65	64	56	55	50	47	68	68	60	59	56	53	72	73	66	64	62	59	73	77	71	67	65	63
	500	68	66	60	59	54	52	71	70	63	62	58	55	75	76	68	66	63	60	76	79	72	69	66	64
7	250	59	55	47	45	42	39	63	60	54	51	50	49	64	63	61	58	57	57	65	63	62	62	62	62
	300	60	56	48	46	44	41	64	62	55	52	51	51	67	66	62	59	58	58	67	66	64	63	62	63
	400	61	59	50	49	46	44	65	65	56	54	52	53	69	70	64	60	59	59	70	71	67	64	63	64
	500	62	61	54	52	48	48	66	66	58	56	53	54	70	72	65	62	59	60	72	74	69	66	63	65
	600	64	62	58	55	50	49	67	67	61	58	54	55	72	73	66	63	60	60	74	76	70	67	63	65
	675	67	64	61	58	52	50	69	68	64	61	56	56	73	74	67	64	60	61	75	77	71	68	63	66
8	350	61	56	48	48	45	41	66	64	56	55	53	50	67	69	63	63	61	58	68	69	67	67	66	63
	475	62	57	50	50	48	44	67	65	57	56	54	51	71	71	64	63	62	59	72	74	69	68	66	64
	600	63	60	53	52	50	47	68	66	58	57	55	53	72	74	65	63	62	60	73	78	71	68	67	65
	700	64	62	56	55	52	49	69	67	60	59	57	54	73	75	66	64	62	60	74	79	72	69	67	65
	800	66	64	59	57	54	50	70	68	61	60	58	55	74	76	67	65	63	61	76	80	73	70	67	65
	900	68	65	62	59	56	52	71	69	64	62	59	57	75	77	68	66	64	62	77	81	74	71	67	66
9	450	58	53	49	49	48	44	65	62	54	53	53	51	68	68	61	58	58	58	69	69	66	64	63	63
	525	59	55	50	50	49	45	66	63	55	54	54	52	69	70	62	59	59	59	71	71	67	64	63	63
	600	60	56	51	51	50	46	67	64	56	55	55	53	71	71	63	60	60	60	72	72	68	65	64	64
	700	61	57	52	52	51	47	68	65	57	57	56	55	72	72	64	61	61	60	73	75	69	66	64	65
	900	62	60	54	54	52	48	68	66	59	58	57	56	73	73	65	62	62	62	75	76	70	67	65	66
	1100	66	63	59	59	53	51	69	67	62	61	58	57	74	74	66	65	64	63	77	78	71	67	67	67
10	550	57	56	51	51	50	46	63	64	57	56	56	53	67	71	65	62	62	60	68	75	69	67	67	65
	675	59	58	53	53	51	45	64	65	58	57	57	54	69	72	66	63	63	61	70	76	70	67	67	65
	800	60	60	54	54	52	47	65	66	60	59	58	55	70	73	67	64	64	62	71	77	71	68	68	66
	1000	62	63	56	56	53	50	66	67	61	60	59	57	71	74	68	65	64	62	73	78	72	69	68	67
	1200	63	65	59	58	55	52	67	69	63	62	61	58	72	75	69	66	66	64	74	79	73	70	69	68
	1400	65	67	62	61	57	54	68	71	65	64	62	59	73	76	70	68	67	65	75	80	73	71	70	68
12	800	59	55	51	52	51	45	66	61	59	57	56	53	72	70	68	62	63	59	73	73	70	68	68	67
	1000	60	56	52	52	53	46	68	63	60	58	57	54	73	71	69	63	64	60	75	74	71	69	69	68
	1200	61	57	54	54	52	47	70	66	61	59	58	55	74	72	70	64	65	61	76	76	72	70	70	69
	1400	62	61	58	56	55	48	69	66	62	60	59	57	75	73	71	65	66	62	77	77	73	70	71	69
	1700	64	64	61	59	57	50	70	67	63	61	60	58	76	75	72	66	67	63	78	78	74	71	72	70
	2000	67	66	64	61	59	55	70	69	66	64	61	59	77	75	73	67	68	64	79	79	75	72	72	70
14	1050	58	54	51	53	54	47	68	62	57	57	58	56	71	69	67	66	63	62	72	73	70	68	68	67
	1400	59	57	56	56	55	50	69	63	59	59	59	57	72	70	68	67	64	63	75	74	71	70	69	69
	1800	63	60	57	57	56	52	71	64	62	60	60	59	73	72	69	68	65	64	76	75	72	71	70	69
	2200	65	62	59	58	57	54	72	67	65	61	61	61	75	73	69	69	66	65	77	76	73	72	71	71
	2600	67	63	63	60	59	56	74	69	66	63	62	62	76	74	70	70	67	66	78	77	74	73	72	72
	3000	69	65	66	63	62	58	75	71	68	64	63	63	78	75	71	71	68	67	80	78	75	74	73	73
16	1400	59	53	51	52	52	48	66	61	58	57	57	56	72	69	67	64	64	63	74	73	70	68	68	68
	1900	61	55	54	54	54	51	67	62	60	59	59	57	73	70	68	65	65	64	75	74	72	69	69	68
	2400	65	59	56	55	55	52	69	65	61	60	60	58	74	71	69	66	66	65	77	75	73	70	70	69
	2900	67	62	59	57	56	53	71	67	63	61	61	59	76	73	70	67	67	66	79	76	74	71	71	70
	3500	71	66	63	60	59	56	73	70	66	64	63	61	79	75	71	68	68	67	81	78	75	72	72	71
	4100	73	69	69	64	62	59	76	73	70	66	65	62	80	77	73	70	70	68	82	81	77	74	73	72

Notes:

- All sound data are measured in accordance with industry standard ARI-880
- Sound power levels are in decibels, re 10⁻¹² watts

Table 14: NC Values – EZTS units with 1/2" Matte Faced Insulation

Inlet Size	Airflow (CFM)	Radiated Noise Criteria (NC)				Discharge Noise Criteria (NC)			
		ΔPs (in w.g.)				ΔPs (in w.g.)			
		0.5	1.0	2.0	3.0	0.5	1.0	2.0	3.0
5	125	---	---	---	---	---	---	---	---
	175	---	---	21	23	---	---	---	---
	250	---	---	25	27	---	---	21	24
	300	---	21	26	30	---	---	24	26
	350	---	24	29	33	---	20	25	27
6	200	---	---	20	22	---	---	---	---
	250	---	---	22	25	---	---	22	22
	300	---	---	24	27	---	20	26	27
	350	---	---	25	30	---	21	27	31
	400	---	---	26	31	---	23	29	34
	500	---	22	27	32	---	25	32	36
7	250	---	---	22	23	---	---	---	---
	300	---	24	24	26	---	---	21	21
	400	---	25	32	31	---	20	26	27
	500	---	26	36	37	---	21	29	31
	600	20	27	37	40	---	22	30	34
	675	21	29	38	41	---	24	31	35
	8	350	---	---	24	24	---	---	24
475		---	---	30	30	---	---	26	30
600		---	20	31	35	---	20	30	35
700		---	21	32	36	---	22	31	36
800		---	22	34	37	---	22	32	37
900		21	24	35	38	---	24	34	38
9	450	---	20	27	34	---	---	22	24
	525	---	21	29	37	---	---	25	26
	600	---	22	30	38	---	---	26	27
	700	---	24	31	39	---	---	27	31
	900	22	25	32	40	---	20	29	32
	1100	24	26	34	41	---	21	30	35
10	550	---	---	26	31	---	---	26	31
	675	---	20	27	32	---	---	27	32
	800	---	21	29	34	---	20	29	34
	1000	---	22	30	35	---	21	30	35
	1200	20	24	31	36	20	24	31	36
	1400	23	26	32	37	21	25	32	37
12	800	---	---	29	32	---	---	26	31
	1000	---	---	30	33	---	---	27	32
	1200	---	20	31	34	---	---	29	34
	1400	---	21	32	35	---	20	30	35
	1700	---	24	34	36	---	21	31	36
	2000	23	26	35	37	---	24	32	37
14	1050	---	20	30	32	---	---	26	31
	1400	---	21	31	35	---	---	27	32
	1800	---	22	32	36	---	20	29	34
	2200	---	24	34	37	---	21	30	35
	2600	22	26	35	38	---	24	31	36
	3000	25	29	35	39	21	26	32	37
16	1400	---	21	31	35	---	---	26	31
	1900	---	22	32	35	---	---	27	32
	2400	---	24	34	36	---	20	29	34
	2900	20	26	35	38	---	22	30	35
	3500	24	29	36	39	20	25	31	36
	4100	27	31	37	40	24	28	34	38
24x16	3000	24	29	36	39	---	24	31	36
	4000	30	34	40	42	24	27	34	38
	5000	35	39	44	46	30	32	37	40
	6000	39	41	46	49	36	37	40	42
	7000	42	45	49	51	38	39	41	44

Table 2: ARI Attenuation Table

	Octave Band							
	2	3	4	5	6	7		
Radiated	2	1	0	0	0	0	0	Environmental Effect
All Sizes	16	18	20	26	31	36		Type II Mineral Fiber
	18	19	20	26	31	36		Total dB Reduction
	Octave Band							
	2	3	4	5	6	7		
Discharge	2	1	0	0	0	0	0	Environmental Effect
Sizes 5-7	2	4	10	20	20	14		5 ft., Duct Lining (12x12)
(300-700	9	5	2	0	0	0		End Reflection
cfm)	6	10	18	20	21	12		5 ft., 8 in. Flex Duct
	5	6	7	8	9	10		Room Effect
	3	3	3	3	3	3		Sound Power Division
	27	29	40	51	53	39		Total dB Reduction
	Octave Band							
	2	3	4	5	6	7		
Discharge	2	1	0	0	0	0	0	Environmental Effect
Sizes	2	3	9	18	17	12		5 ft., Duct Lining (15x15)
8-24x16	9	5	2	0	0	0		End Reflection
(>700 cfm)	6	10	18	20	21	12		5 ft., 8 in. Flex Duct
	5	6	7	8	9	10		Room Effect
	5	5	5	5	5	5		Sound Power Division
	29	30	41	51	52	39		Total dB Reduction

Notes:

1. NC values are calculated based on procedures outlined in ARI standard 885, appendix E as shown in table 2
2. Where no NC value is shown (---), NC values are less than 20

Table 15: Radiated Sound Power Data (dB) – EZTA units with integral sound attenuator and EZTE units with integral electric heat

Inlet Size	Airflow (CFM)	0.5" ΔPs						1.0" ΔPs						2.0" ΔPs						3.0" ΔPs					
		Sound Power Levels, dB						Sound Power Levels, dB						Sound Power Levels, dB						Sound Power Levels, dB					
		Octave Band						Octave Band						Octave Band						Octave Band					
		2	3	4	5	6	7	2	3	4	5	6	7	2	3	4	5	6	7	2	3	4	5	6	7
5	125	46	41	33	30	27	24	51	43	39	34	33	27	50	46	43	39	38	33	50	47	44	42	42	37
	175	49	44	35	31	28	25	52	48	41	37	35	28	54	51	47	42	40	34	54	52	49	45	44	38
	250	52	47	39	33	30	26	55	51	44	38	36	29	58	56	50	45	43	35	58	58	53	48	46	39
	300	53	49	41	35	32	27	56	53	46	40	37	30	60	57	52	46	44	36	60	60	55	50	48	40
	350	54	50	44	37	34	32	58	55	48	41	39	34	62	58	54	47	45	38	62	61	58	51	49	41
6	200	49	42	35	29	28	27	52	47	40	34	34	31	52	49	46	39	40	37	53	50	48	42	43	40
	250	50	43	36	30	30	28	53	48	41	35	35	32	55	53	48	41	41	38	55	53	51	44	44	41
	300	51	44	37	31	31	29	54	49	42	36	36	33	57	55	49	42	42	39	57	56	53	46	45	42
	350	52	45	39	32	32	30	55	50	43	37	37	34	58	56	50	43	43	40	59	59	55	48	46	43
	400	53	46	41	34	33	31	56	51	44	38	38	35	60	57	51	44	44	41	60	61	56	49	47	44
500	56	50	45	38	37	35	58	53	48	40	40	38	62	58	53	46	45	42	63	62	57	50	49	45	
7	250	50	46	38	33	30	26	52	51	44	39	36	31	52	52	48	43	41	36	52	53	49	46	44	41
	300	51	47	39	35	31	27	53	55	46	40	37	32	53	55	50	45	43	38	54	56	52	48	45	42
	400	52	48	40	36	33	28	56	56	48	42	39	33	56	62	54	49	45	40	57	61	56	51	48	43
	500	55	49	42	38	34	30	57	57	49	43	40	34	59	65	58	52	47	41	59	66	60	55	50	45
	600	58	50	45	40	36	31	60	58	50	44	41	35	61	66	59	53	48	42	61	69	63	58	52	46
	675	59	51	47	42	38	32	61	59	51	45	42	36	64	67	60	54	49	43	63	70	65	60	53	47
8	350	49	44	36	31	29	29	53	50	43	38	36	34	54	55	50	45	43	40	55	55	52	48	47	44
	475	50	45	37	33	32	30	54	51	44	39	37	35	56	60	51	46	44	41	57	60	56	51	48	44
	600	51	46	39	35	33	31	55	52	45	40	38	36	58	61	52	47	45	41	59	64	58	52	49	45
	700	53	47	41	37	36	32	56	53	46	41	39	37	60	62	53	48	45	42	60	65	59	53	50	46
	800	54	49	44	40	38	33	57	54	47	43	41	38	61	63	54	49	46	43	62	66	60	54	50	47
	900	56	50	47	43	40	35	59	55	49	45	43	39	63	64	55	50	47	44	63	67	61	55	51	47
9	450	47	44	37	33	31	26	51	52	43	38	36	31	55	58	51	45	43	38	57	63	55	49	47	42
	525	48	45	38	34	32	27	52	53	44	39	37	32	57	59	52	46	44	39	58	66	57	50	48	43
	600	49	46	39	35	33	28	53	54	45	40	38	33	58	60	53	47	45	40	59	67	58	51	49	44
	700	53	49	41	36	34	29	54	55	46	41	39	34	59	61	54	48	46	41	60	68	59	52	50	45
	900	55	54	45	39	36	31	55	56	48	43	40	35	60	62	55	49	47	42	61	69	60	53	51	46
	1100	56	55	48	42	38	33	56	57	50	44	41	36	61	63	56	50	48	44	63	70	61	54	52	47
10	550	49	43	38	34	33	28	52	51	43	40	39	35	54	57	50	46	45	40	55	61	53	51	48	43
	675	50	44	40	36	34	29	53	52	44	41	40	36	56	58	51	47	46	41	56	62	54	51	49	44
	800	51	46	41	37	35	30	54	53	45	42	41	37	57	59	52	48	47	42	58	63	55	52	50	45
	1000	52	48	44	39	37	31	55	54	47	43	42	38	59	60	53	49	48	43	60	64	56	53	51	46
	1200	55	51	46	41	39	34	57	55	49	45	43	39	61	61	54	50	49	44	62	65	57	53	52	47
	1400	57	53	49	44	41	36	59	56	52	48	46	40	63	62	55	51	50	45	64	66	58	54	53	48
12	800	51	44	37	34	33	27	56	50	43	39	39	33	60	59	51	46	44	39	60	60	57	50	48	43
	1000	52	45	38	35	34	29	57	51	44	40	40	34	62	60	52	47	45	40	62	62	58	51	49	44
	1200	53	47	40	37	35	30	58	52	45	41	41	35	63	61	53	48	46	41	64	63	59	52	50	45
	1400	54	48	42	39	36	31	59	53	46	43	42	36	64	62	54	49	47	42	66	64	59	53	51	46
	1700	56	51	45	42	39	32	60	55	48	45	43	37	65	63	55	50	48	43	68	65	60	54	52	47
	2000	58	53	49	45	42	35	62	57	51	47	45	38	67	64	56	51	49	44	69	66	60	55	53	48
14	1050	51	44	36	35	34	30	57	52	42	39	39	36	61	60	51	47	45	42	61	63	55	50	49	45
	1400	52	45	39	36	36	31	58	53	43	40	40	37	63	61	52	48	46	43	64	64	56	51	50	46
	1800	54	48	41	38	37	32	59	54	45	43	42	38	64	62	53	49	47	44	66	65	57	52	51	47
	2200	56	51	45	41	39	35	60	55	47	44	44	39	65	63	54	50	49	45	67	66	58	53	52	48
	2600	59	54	48	44	42	37	62	57	50	46	45	41	66	64	55	51	50	46	69	67	59	54	53	49
	3000	61	56	51	47	45	40	64	59	53	49	47	43	68	64	56	52	52	47	70	68	60	55	54	50
16	1400	50	45	38	36	37	32	57	53	44	41	40	37	61	61	51	48	46	42	63	64	55	51	50	46
	1900	52	47	40	38	38	33	58	54	45	42	41	38	64	62	52	49	47	43	65	64	56	52	51	47
	2400	55	50	43	41	40	36	60	55	46	45	44	39	65	63	53	50	48	44	67	65	57	53	52	48
	2900	58	52	45	43	41	38	62	57	48	46	46	41	67	64	54	51	50	46	69	67	58	54	53	49
	3500	61	55	48	45	43	40	64	59	51	48	47	42	68	65	55	52	51	47	70	68	59	55	54	50
	4100	64	58	52	48	45	42	66	61	54	50	49	44	69	66	56	53	52	48	71	69	60	56	55	51
24x16	3000	61	54	49	44	40	35	65	57	52	48	44	38	71	64	58	53	50	44	73	68	63	57	53	48
	4000	66	59	55	48	44	38	69	62	56	51	46	41	74	67	60	55	51	45	76	70	64	58	54	49
	5000	70	63	59	53	48	41	73	65	60	54	51	45	77	69	63	58	53	47	79	72	65	59	56	50
	6000	73	67	63	56	51	44	75	69	63	56	52	47	79	70	64	59	54	48	81	73	66	60	57	51
	7000	76	70	66	59	54	46	78	71	66	58	54	50	81	72	66	60	55	49	83	74	67	61	58	52

Notes:

1. All sound data are measured in accordance with industry standard ARI-880
2. Sound power levels are in decibels, re 10⁻¹² watts

Table 16: Discharge Sound Power Data (dB) – EZTA units with integral sound attenuator and EZTE units with integral electric heat – 1/2" Matte Faced Insulation

Inlet Size	Airflow (CFM)	0.5" ΔPs						1.0" ΔPs						2.0" ΔPs						3.0" ΔPs					
		Sound Power Levels, dB						Sound Power Levels, dB						Sound Power Levels, dB						Sound Power Levels, dB					
		Octave Band						Octave Band						Octave Band						Octave Band					
		2	3	4	5	6	7	2	3	4	5	6	7	2	3	4	5	6	7	2	3	4	5	6	7
5	125	57	50	40	35	26	23	59	53	46	40	31	28	58	53	49	45	38	36	58	53	50	46	41	41
	175	59	54	43	37	28	24	62	58	48	42	33	29	63	59	53	48	39	37	62	59	55	51	43	42
	250	61	56	47	40	31	26	65	61	51	45	36	31	68	64	57	50	40	37	67	65	59	53	44	42
	300	62	58	50	43	34	27	66	63	54	47	37	31	70	66	59	52	42	38	70	67	62	55	45	43
	350	63	59	53	47	38	36	68	65	57	49	40	38	71	67	61	54	44	43	73	69	64	57	47	44
6	200	58	51	42	38	27	23	62	55	48	42	33	28	63	57	55	49	40	36	62	57	56	52	44	41
	250	59	54	44	40	28	24	62	59	49	43	34	29	65	61	56	49	40	37	64	61	58	54	44	42
	300	60	56	46	41	29	25	63	61	51	45	35	30	66	63	57	50	41	37	67	65	60	54	44	42
	350	62	57	49	43	31	26	65	62	52	47	36	31	68	64	58	51	42	38	69	67	61	55	45	42
	400	63	58	50	44	32	26	65	62	53	48	37	31	69	65	58	52	42	38	69	68	62	55	45	43
	500	66	62	55	50	36	33	69	65	59	52	40	37	73	70	62	56	45	41	74	71	65	58	48	44
7	250	57	51	42	39	28	24	61	56	50	44	35	31	62	58	57	51	42	39	62	59	57	55	46	44
	300	58	52	44	40	29	25	62	58	50	44	35	32	64	60	58	51	42	40	65	61	60	56	46	45
	400	60	57	46	42	31	27	62	61	51	46	37	34	67	65	59	52	42	40	67	66	62	57	47	45
	500	61	58	50	46	34	29	64	62	53	48	38	35	68	67	59	53	44	41	70	68	63	58	47	46
	600	63	59	54	49	35	31	66	63	56	52	40	37	71	67	61	55	45	43	72	70	65	59	48	47
	675	65	61	56	52	37	33	68	64	59	54	41	38	72	68	62	56	46	43	74	70	66	60	49	48
8	350	56	49	43	40	32	26	61	53	49	44	37	34	63	59	55	50	42	40	65	60	60	56	48	44
	475	60	53	45	42	33	27	62	56	51	46	38	34	66	60	55	49	42	41	68	64	60	55	45	45
	600	60	56	48	45	35	29	64	58	52	48	40	35	69	63	56	51	44	43	70	67	61	55	46	46
	700	62	57	51	47	36	30	66	60	54	49	41	37	70	65	58	53	45	43	72	68	62	56	48	47
	800	64	58	54	50	38	32	67	62	56	51	42	38	72	66	60	55	46	45	74	69	64	58	50	48
	900	64	59	55	51	39	33	68	63	57	53	43	39	73	67	61	56	48	45	75	70	65	60	50	49
9	450	55	50	44	40	33	29	57	57	49	45	40	37	62	61	56	49	45	44	63	63	61	54	49	48
	525	57	52	45	42	35	31	59	58	51	45	41	38	63	63	57	50	46	45	64	64	62	54	50	49
	600	57	54	46	43	37	32	61	59	52	47	42	39	65	65	58	51	47	46	67	66	63	56	51	50
	700	58	56	48	44	39	33	63	62	53	48	43	40	67	66	60	53	48	47	68	68	64	56	52	51
	900	60	58	52	48	41	36	65	64	55	51	44	42	68	68	62	55	50	49	71	71	66	59	53	53
	1100	63	61	56	53	41	38	66	64	58	54	46	43	71	70	63	58	51	50	73	73	67	60	54	54
10	550	57	52	45	41	36	30	57	55	51	45	42	39	63	59	57	49	47	46	65	65	59	52	51	49
	675	57	53	46	43	37	32	60	58	53	47	44	40	65	60	59	51	49	47	68	65	62	53	51	51
	800	59	55	48	44	39	33	62	61	54	49	45	42	66	62	61	53	49	48	68	65	63	55	52	52
	1000	60	59	51	47	40	36	63	63	55	51	46	44	69	67	64	56	51	50	70	68	66	58	54	54
	1200	62	61	54	50	43	38	65	64	58	53	48	45	71	70	65	58	53	51	73	72	68	61	56	55
	1400	64	63	57	53	45	41	67	66	60	56	49	46	72	71	66	60	55	53	74	74	69	63	58	56
12	800	56	51	45	43	40	35	56	53	51	47	46	43	64	58	59	52	51	49	67	63	58	55	53	54
	1000	58	52	47	44	42	36	60	56	53	49	47	45	65	60	62	54	52	51	68	64	61	57	54	55
	1200	59	54	49	45	42	38	64	60	54	50	48	46	68	63	64	56	54	53	71	65	64	60	56	57
	1400	60	55	52	47	43	39	65	61	56	51	49	47	71	67	66	57	55	53	73	67	66	62	58	57
	1700	62	58	56	54	45	42	67	63	58	56	50	48	74	70	68	60	56	55	76	72	68	64	59	58
	2000	65	61	60	55	48	44	69	65	61	57	52	50	76	71	69	61	57	56	78	74	70	65	61	59
14	1050	57	51	47	45	41	37	61	58	53	50	49	47	64	60	59	55	54	52	67	63	61	58	58	57
	1400	60	53	50	47	44	39	65	60	56	52	51	48	67	63	62	57	56	54	70	64	64	60	59	58
	1800	63	56	54	53	46	42	68	63	58	55	52	49	72	68	64	60	57	55	74	69	67	62	61	59
	2200	65	59	56	53	48	44	69	63	59	56	53	51	74	70	65	61	59	57	76	72	69	64	62	61
	2600	67	62	60	53	50	46	71	65	61	56	54	51	76	71	67	62	60	58	78	75	70	66	63	62
	3000	70	64	63	56	52	49	73	67	64	59	56	53	77	72	68	63	61	59	80	76	72	67	64	63
16	1400	57	52	47	46	44	40	62	59	54	51	53	50	66	64	61	56	56	55	69	66	64	59	58	58
	1900	60	54	50	50	47	43	65	61	56	53	53	51	70	67	64	60	58	56	72	69	68	62	60	60
	2400	63	57	53	52	48	44	67	62	58	55	53	52	73	70	66	61	59	59	75	72	70	64	63	62
	2900	65	60	56	52	50	46	70	64	60	56	54	53	75	71	67	62	60	59	77	75	71	66	64	63
	3500	69	63	60	56	52	49	73	67	62	58	56	54	78	72	68	63	62	60	80	77	72	67	65	64
	4100	72	66	66	58	55	52	75	69	67	60	58	56	80	74	70	64	63	61	82	78	74	68	66	65
24x16	3000	62	60	56	55	51	47	67	65	61	59	56	54	73	71	66	64	62	60	76	74	68	67	65	63
	4000	67	65	61	57	54	51	71	68	64	63	59	56	75	74	68	68	64	62	79	77	71	70	68	66
	5000	72	70	66	62	57	55	75	72	67	65	62	59	78	77	71	70	67	64	82	79	74	73	70	68
	6000	77	76	70	65	60	57	78	76	71	67	64	61	82	80	75	73	69	66	85	81	76	73	71	69
	7000	80	78	74	67	62	60	80	78	73	70	65	63	84	80	76	75	69	68	87	82	77	74	72	71

Notes:
1. All sound data are measured in accordance with industry standard ARI-880
2. Sound power levels are in decibels, re 10⁻¹² watts

Table 17: NC Values – EZTA units with integral sound attenuator and EZTE units with integral electric heat – 1/2" Matte Faced Insulation

Inlet Size	Airflow (CFM)	Radiated Noise Criteria (NC)				Discharge Noise Criteria (NC)			
		ΔPs (in w.g.)				ΔPs (in w.g.)			
		0.5	1.0	2.0	3.0	0.5	1.0	2.0	3.0
5	125	---	---	---	---	---	---	---	---
	175	---	---	21	23	---	---	---	---
	250	---	---	25	27	---	---	---	---
	300	---	21	26	30	---	---	20	21
	350	---	24	29	33	---	---	21	23
6	200	---	---	20	22	---	---	---	---
	250	---	---	22	25	---	---	---	---
	300	---	---	24	27	---	---	---	---
	350	---	---	25	30	---	---	---	21
	400	---	---	26	31	---	---	---	22
	500	---	22	27	32	---	---	25	26
7	250	---	---	22	23	---	---	---	---
	300	---	24	24	26	---	---	---	---
	400	---	25	32	31	---	---	20	21
	500	---	26	36	37	---	---	22	24
	600	20	27	37	40	---	---	23	26
	675	21	29	38	41	---	---	24	26
	8	350	---	---	24	24	---	---	---
475		---	---	30	30	---	---	---	---
600		---	20	31	35	---	---	---	21
700		---	21	32	36	---	---	---	22
800		---	22	34	37	---	---	20	24
900		21	24	35	38	---	---	21	25
9	450	---	20	27	34	---	---	---	---
	525	---	21	29	37	---	---	---	---
	600	---	22	30	38	---	---	---	20
	700	---	24	31	39	---	---	20	22
	900	22	25	32	40	---	---	22	26
	1100	24	26	34	41	---	---	25	29
10	550	---	---	26	31	---	---	---	---
	675	---	20	27	32	---	---	---	---
	800	---	21	29	34	---	---	---	---
	1000	---	22	30	35	---	---	21	22
	1200	20	24	31	36	---	---	25	27
	1400	23	26	32	37	---	20	26	30
12	800	---	---	29	32	---	---	---	---
	1000	---	---	30	33	---	---	---	---
	1200	---	20	31	34	---	---	---	20
	1400	---	21	32	35	---	---	22	22
	1700	---	24	34	36	---	---	26	29
	2000	23	26	35	37	---	20	27	31
14	1050	---	20	30	32	---	---	---	---
	1400	---	21	31	35	---	---	---	20
	1800	---	22	32	36	---	---	25	26
	2200	---	24	34	37	---	---	27	30
	2600	22	26	35	38	---	21	29	34
	3000	25	29	35	39	20	24	30	35
16	1400	---	21	31	35	---	---	20	22
	1900	---	22	32	35	---	---	24	26
	2400	---	24	34	36	---	---	27	30
	2900	20	26	35	38	---	20	29	34
	3500	24	29	36	39	---	24	30	36
	4100	27	31	37	40	22	26	32	37
24x16	3000	24	29	36	39	---	21	29	33
	4000	30	34	40	42	21	25	32	36
	5000	35	39	44	46	27	30	36	38
	6000	39	41	46	49	35	35	39	40
	7000	42	45	49	51	37	37	39	41

Table 2: ARI Attenuation Table

	Octave Band							
	2	3	4	5	6	7		
Radiated	2	1	0	0	0	0	0	Environmental Effect
All Sizes	16	18	20	26	31	36		Type II Mineral Fiber
	18	19	20	26	31	36		Total dB Reduction
	Octave Band							
	2	3	4	5	6	7		
Discharge	2	1	0	0	0	0	0	Environmental Effect
Sizes 5-7	2	4	10	20	20	14		5 ft., Duct Lining (12x12)
(300-700 cfm)	9	5	2	0	0	0		End Reflection
	6	10	18	20	21	12		5 ft., 8 in. Flex Duct
	5	6	7	8	9	10		Room Effect
	3	3	3	3	3	3		Sound Power Division
	27	29	40	51	53	39		Total dB Reduction
	Octave Band							
	2	3	4	5	6	7		
Discharge	2	1	0	0	0	0	0	Environmental Effect
Sizes	2	3	9	18	17	12		5 ft., Duct Lining (15x15)
8-24x16	9	5	2	0	0	0		End Reflection
(>700 cfm)	6	10	18	20	21	12		5 ft., 8 in. Flex Duct
	5	6	7	8	9	10		Room Effect
	5	5	5	5	5	5		Sound Power Division
	29	30	41	51	52	39		Total dB Reduction

Notes:

1. NC values are calculated based on procedures outlined in ARI standard 885, appendix E as shown in table 2
2. Where no NC value is shown (---), NC values are less than 20

Table 18: Hot Water Heating Coil Performance – Inlet Sizes 05, 06

	Water Flow (GPM)	Water PD (ft. w.g.)	AIR FLOW CFM									
			50	100	150	200	250	300	350	400	450	
5", 6" EZT 1 Row	0.50	0.2	MBH	3.6	5.5	6.8	7.7	8.5	9.2	9.8	10.2	10.7
	1.00	0.6		3.8	6.0	7.5	8.8	9.9	10.8	11.6	12.3	13.0
	2.00	1.9		3.9	6.3	8.0	9.5	10.8	11.9	12.9	13.8	14.6
	3.00	3.9		4.0	6.4	8.2	9.8	11.2	12.3	13.4	14.4	15.3
	4.00	6.5		4.0	6.4	8.3	9.9	11.3	12.6	13.7	14.7	15.7
5", 6" EZT 2 Row	1.00	0.3	MBH	5.5	8.9	11.5	13.6	15.2	16.6	17.8	18.9	19.8
	2.00	1.1		5.6	9.5	12.6	15.1	17.2	19.1	20.7	22.2	23.5
	3.00	2.4		5.7	9.7	13.0	15.7	18.0	20.1	21.9	23.6	25.1
	4.00	4.1		5.7	9.8	13.2	16.0	18.4	20.6	22.6	24.4	26.1
	5.00	6.2		5.8	9.9	13.3	16.2	18.7	21.0	23.0	24.9	26.6
5", 6" EZT 4 Row	3.00	0.5	MBH	6.9	12.7	17.7	22.0	25.7	29.0	32.0	34.7	37.2
	4.00	0.8		6.9	12.9	18.0	22.5	26.4	30.0	33.3	36.2	38.9
	5.00	1.3		6.9	12.9	18.2	22.8	26.9	30.6	34.1	37.2	40.1
	6.00	1.8		6.9	13.0	18.3	23.0	27.2	31.1	34.6	37.9	40.9
	7.00	2.4		7.0	13.0	18.4	23.1	27.5	31.4	35.0	38.4	41.5

Table 19: Hot Water Heating Coil Performance – Inlet Sizes 07, 08

	Water Flow (GPM)	Water PD (ft. w.g.)	AIR FLOW CFM									
			100	200	300	400	500	600	700	800	900	
7", 8" EZT 1 Row	0.50	0.2	MBH	5.8	8.3	10.0	11.1	12.1	12.8	13.4	13.9	14.3
	1.00	0.6		6.3	9.5	11.7	13.4	14.8	15.9	16.9	17.8	18.5
	2.00	2.1		6.6	10.2	12.9	15.0	16.7	18.2	19.5	20.7	21.7
	3.00	4.2		6.8	10.5	13.3	15.6	17.5	19.2	20.6	22.0	23.2
	4.00	7.0		6.8	10.7	13.6	15.9	18.0	19.7	21.3	22.7	24.0
7", 8" EZT 2 Row	1.00	0.3	MBH	9.4	14.5	17.9	20.4	22.4	24.0	25.3	26.4	27.4
	2.00	1.1		10.0	16.0	20.4	23.9	26.7	29.1	31.2	33.0	34.6
	3.00	2.4		10.2	16.6	21.4	25.4	28.6	31.4	33.9	36.1	38.1
	4.00	4.2		10.3	16.9	22.0	26.2	29.7	32.8	35.5	37.9	40.1
	5.00	6.4		10.3	17.1	22.4	26.7	30.4	33.6	36.5	39.1	41.4
7", 8" EZT 4 Row	2.00	0.2	MBH	12.8	22.0	28.8	34.2	38.5	42.0	45.1	47.6	49.9
	3.00	0.5		13.0	22.9	30.6	36.8	42.1	46.5	50.3	53.7	56.7
	4.00	0.9		13.1	23.3	31.5	38.3	44.1	49.1	53.4	57.3	60.8
	6.00	1.9		13.3	23.8	32.5	39.9	46.3	52.0	57.0	61.5	65.6
	8.00	3.2		13.3	24.1	33.1	40.8	47.6	53.6	59.0	63.9	68.3

Table 20: Hot Water Heating Coil Performance – Inlet Sizes 09, 10

	Water Flow (GPM)	Water PD (ft. w.g.)	AIR FLOW CFM									
			300	425	550	675	800	925	1050	1175	1300	
9", 10" EZT 1 Row	0.50	0.2	MBH	11.6	13.4	14.6	15.6	16.4	17.1	17.7	18.1	18.6
	1.00	0.8		13.6	16.2	18.2	19.8	21.2	22.3	23.4	24.3	25.1
	2.00	2.7		14.9	18.1	20.7	22.8	24.7	26.4	27.8	29.2	30.4
	3.00	5.6		15.4	18.8	21.7	24.1	26.2	28.1	29.8	31.3	32.7
	4.00	9.3		15.7	19.2	22.2	24.8	27.0	29.1	30.9	32.5	34.1
9", 10" EZT 2 Row	1.00	0.4	MBH	20.5	24.2	27.0	29.2	31.0	32.5	33.8	34.8	35.8
	2.00	1.3		23.2	28.4	32.5	36.0	38.9	41.4	43.6	45.6	47.3
	3.00	2.8		24.3	30.1	34.9	38.9	42.4	45.5	48.2	50.7	52.9
	4.00	4.9		24.9	31.0	36.2	40.6	44.5	47.9	50.9	53.7	56.3
	5.00	7.4		25.2	31.6	37.0	41.7	45.8	49.4	52.7	55.7	58.5
9", 10" EZT 4 Row	2.00	0.3	MBH	31.9	39.8	46.0	50.9	55.0	58.5	61.5	64.0	66.3
	4.00	1.1		34.4	44.3	52.5	59.6	65.7	71.1	75.9	80.2	84.1
	6.00	2.3		35.3	45.9	55.1	63.1	70.1	76.5	82.2	87.4	92.1
	8.00	3.9		35.7	46.8	56.4	64.9	72.5	79.4	85.7	91.4	96.7
	10.00	5.8		36.0	47.3	57.3	66.1	74.1	81.3	87.9	94.0	99.7

1 MBH = 1,000 BTU / HR
GPM = Gallons / Min
CFM = Cubic Feet / Min
See page B-24 for calculation details.

Note: All selections based on 180°F EWT and 55°F EAT (125°ΔT). For other ΔT's adjust capacities by the following factors:

ΔT	65	75	85	95	105	115	125	135	145	155	165
Factor	.51	.59	.67	.75	.83	.92	1.00	1.08	1.17	1.25	1.33

Single Duct Air Terminals

B

Table 21: Hot Water Heating Coil Performance – Inlet Size 12

	Water Flow (GPM)	Water PD (ft. w.g.)		AIR FLOW CFM								
				400	600	800	1000	1200	1400	1600	1800	2000
12" EZT 1 Row	1.00	0.1	MBH	15.9	18.8	20.8	22.4	23.7	24.7	25.6	26.4	27.0
	2.00	0.3		18.4	22.4	25.6	28.0	30.1	31.9	33.4	34.7	35.9
	3.00	0.5		19.4	24.1	27.7	30.7	33.2	35.4	37.3	39.0	40.5
	4.00	0.9		20.0	25.0	29.0	32.3	35.1	37.5	39.7	41.6	43.4
	5.00	1.4		20.4	25.7	29.9	33.4	36.4	39.0	41.3	43.4	45.3
12" EZT 2 Row	1.00	0.4	MBH	26.2	31.3	34.8	37.4	39.4	41.1	42.4	43.5	44.4
	2.00	1.6		30.4	38.1	43.9	48.5	52.3	55.5	58.2	60.5	62.6
	3.00	3.3		32.1	40.9	47.9	53.6	58.3	62.5	66.1	69.2	72.0
	4.00	5.6		33.0	42.5	50.1	56.5	61.9	66.6	70.8	74.5	77.8
	5.00	8.5		33.6	43.5	51.6	58.4	64.2	69.3	73.9	78.0	81.7
12" EZT 4 Row	2.00	0.4	MBH	41.6	52.9	61.1	67.3	72.1	76.0	79.2	81.9	84.2
	4.00	1.3		45.5	60.5	72.6	82.4	90.7	97.8	103.9	109.3	114.0
	6.00	2.7		46.9	63.4	77.1	88.7	98.6	107.4	115.1	122.0	128.2
	8.00	4.6		47.6	64.9	79.5	92.0	103.0	112.8	121.5	129.4	136.5
	10.00	7.0		48.0	65.8	81.0	94.2	105.8	116.3	125.6	134.2	142.0

Table 22: Hot Water Heating Coil Performance – Inlet Size 14

	Water Flow (GPM)	Water PD (ft. w.g.)		AIR FLOW CFM								
				500	800	1100	1400	1700	2000	2300	2600	2900
14" EZT 1 Row	2.00	0.3	MBH	24.0	30.2	34.8	38.3	41.1	43.5	45.5	47.3	48.8
	3.00	0.6		25.5	32.7	38.1	42.5	46.0	49.1	51.7	54.0	56.1
	4.00	1.1		26.3	34.1	40.1	45.0	49.0	52.5	55.6	58.3	60.7
	5.00	1.6		26.9	35.1	41.4	46.7	51.0	54.9	58.2	61.2	63.9
	6.00	2.3		27.2	35.7	42.4	47.9	52.5	56.6	60.1	63.3	66.2
14" EZT 2 Row	2.00	0.5	MBH	37.9	48.4	55.8	61.3	65.6	69.2	72.1	74.5	76.7
	3.00	1.1		40.5	53.2	62.5	69.9	75.8	80.8	85.0	88.6	91.8
	4.00	1.8		42.0	55.9	66.5	75.0	82.0	88.0	93.2	97.7	101.7
	6.00	3.8		43.5	58.9	70.9	80.9	89.3	96.5	102.9	108.6	113.7
	8.00	6.4		44.3	60.5	73.4	84.1	93.4	101.4	108.6	115.0	120.8
14" EZT 4 Row	4.00	1.0	MBH	57.4	79.3	95.7	108.6	118.9	127.4	134.5	140.6	145.9
	6.00	2.1		59.4	84.0	103.5	119.5	132.8	144.2	154.0	162.5	170.1
	8.00	3.5		60.5	86.5	107.8	125.5	140.7	153.8	165.4	175.6	184.8
	10.00	5.3		61.1	88.0	110.4	129.4	145.8	160.1	172.9	184.3	194.6
	12.00	7.4		61.5	89.1	112.2	132.0	149.3	164.6	178.2	190.5	201.7

Table 23: Hot Water Heating Coil Performance – Inlet Size 16

	Water Flow (GPM)	Water PD (ft. w.g.)		AIR FLOW CFM								
				600	1025	1450	1875	2300	2725	3150	3575	4000
16" EZT 1 Row	2.00	0.3	MBH	28.3	36.5	42.1	46.3	49.6	52.3	54.6	56.5	58.2
	3.00	0.7		30.2	39.9	46.8	52.1	56.4	60.0	63.1	65.8	68.2
	4.00	1.2		31.3	41.8	49.6	55.7	60.7	64.9	68.5	71.7	74.6
	5.00	1.7		32.0	43.1	51.4	58.1	63.5	68.2	72.3	75.9	79.1
	6.00	2.4		32.5	44.1	52.8	59.8	65.6	70.7	75.1	79.0	82.5
16" EZT 2 Row	2.00	0.6	MBH	44.3	57.6	66.2	72.4	77.0	80.6	83.5	86.0	88.0
	3.00	1.2		47.8	64.4	75.9	84.5	91.2	96.7	101.3	105.2	108.6
	4.00	2.0		49.7	68.2	81.6	91.9	100.2	107.1	112.9	118.0	122.4
	6.00	4.1		51.8	72.5	88.1	100.6	110.9	119.6	127.2	133.8	139.7
	8.00	6.9		52.8	74.8	91.8	105.5	117.0	126.9	135.6	143.2	150.2
16" EZT 4 Row	4.00	1.1	MBH	68.0	96.6	116.7	131.5	142.8	151.8	159.2	165.3	170.5
	6.00	2.2		70.7	103.8	128.6	148.0	163.7	176.7	187.6	197.0	205.1
	8.00	3.8		72.1	107.5	135.1	157.4	175.9	191.5	204.9	216.6	226.9
	10.00	5.7		73.0	109.8	139.3	163.4	183.8	201.3	216.5	230.0	241.9
	12.00	7.9		73.5	111.4	142.1	167.6	189.4	208.3	224.9	239.6	252.8

1 MBH = 1,000 BTU / HR
GPM = Gallons / Min
CFM = Cubic Feet / Min
See page B-24 for calculation details.

Note: All selections based on 180°F EWT and 55°F EAT (125°ΔT). For other ΔT's adjust capacities by the following factors:											
ΔT	65	75	85	95	105	115	125	135	145	165	
Factor	.51	.59	.67	.75	.83	.92	1.00	1.08	1.17	1.25	1.33

Table 24: Hot Water Heating Coil Performance – Inlet Size 24x16

	Water Flow (GPM)	Water PD (ft. w.g.)		AIR FLOW CFM									
				1000	1750	2500	3250	4000	4750	5500	6250	7000	
24"x16" EZT 1 Row	2.00	1.1	MBH	44.4	56.6	64.5	70.2	74.5	77.9	80.7	83.0	85.0	
	3.00	2.4		48.2	63.4	73.8	81.5	87.7	92.7	96.9	100.5	103.6	
	4.00	4.0		50.3	67.3	79.3	88.5	95.9	102.1	107.3	111.9	115.9	
	5.00	5.9		51.6	69.9	83.0	93.3	101.6	108.6	114.7	120.0	124.6	
	6.00	8.2		52.6	71.7	85.7	96.7	105.8	113.5	120.1	125.9	131.2	
24"x16" EZT 2 Row	2.00	0.4	MBH	64.2	79.7	88.5	94.2	98.1	101.1	103.4	105.2	106.7	
	3.00	0.8		72.0	93.9	107.5	117.0	124.0	129.4	133.8	137.4	140.4	
	4.00	1.3		76.5	102.5	119.7	132.2	141.8	149.3	155.6	160.8	165.2	
	6.00	2.7		81.3	112.5	134.4	151.1	164.3	175.2	184.4	192.2	199.0	
	8.00	4.5		83.9	118.1	142.9	162.3	178.1	191.3	202.5	212.3	220.9	
24"x16" EZT 4 Row	2.00	0.6	MBH	87.1	105.2	113.1	117.2	119.7	121.2	122.4	123.1	123.7	
	3.00	1.3		99.9	130.7	147.3	157.2	163.8	168.3	171.6	174.1	176.1	
	4.00	2.1		106.6	146.2	170.1	185.8	196.8	204.8	211.0	215.7	219.6	
	6.00	4.4		113.4	163.4	197.6	222.3	240.9	255.4	267.0	276.5	284.5	
	8.00	7.3		116.7	172.6	213.1	243.9	268.1	287.7	303.9	317.5	329.1	

Note: All selections based on 180°F EWT and 55°F EAT (125°ΔT). For other ΔT's adjust capacities by the following factors:

ΔT	65	75	85	95	105	115	125	135	145	155	165
Factor	.51	.59	.67	.75	.83	.92	1.00	1.08	1.17	1.25	1.33

Reheat Coil Definitions

- CFM = Ft³ / minute
- BTUH = BTU / hour
- 1 MBH = 1,000 BTU's / hour = 1,000 BTUH
- GPM = Gallons / minute
- EAT = Entering Air Temperature, °F
- LAT = Leaving Air Temperature, °F
- ΔT_A = Differential air temperature, °F = LAT - EAT
- EWT = Entering Water Temperature, °F
- LWT = Leaving Water Temperature, °F
- ΔT_W = Differential water temperature, °F = EWT - LWT
- kW = Kilowatt
- 1 kW = 3412 BTU / HR

Water Coil Equations

BTUH = CFM x 1.08 x ΔT_A = CFM x 1.08 x (LAT - EAT)
 ΔT_A = MBH x 926 / CFM
 ΔT_W = MBH x 2 / GPM

Electric Coil Equations

kW = CFM x ΔT_A / 3,160 = CFM x (LAT - EAT) / 3,160
 ΔT_A = 3160 x kW / CFM

Sizing Reheat Coils:

- Knowing the heating load of the space (BTUH or MBH), room temp setpoint, and the air flow rate during heating (based on minimum ventilation rates, max recommended discharge temps for best ADPI, etc.), determine the supply air temperature required to satisfy the load:

$$\text{Supply Air Temp} = (\text{MBH} \times 926 / \text{CFM}) + \text{Room Temp Setpoint}$$

- The Supply Air Temp into the space is the required Leaving Air Temperature from the coil (assuming no duct heat loss). Applying energy transfer equations for electric or hot water coils determines performance characteristics required to select the coil:

Water Coils: BTUH = CFM x 1.08 x (LAT - EAT)

Electric Coils: kW = CFM x (LAT - EAT) / 3,160

Single Duct Air Terminals

B

EZTE ELECTRIC HEAT SINGLE DUCT FEATURES:

- Primary over temperature protection provided by auto reset thermal cutout – disc type
- Secondary over temperature protection with manual reset (push button) thermal cutout – disc type
- De-rated Nickel Chrome heating elements
- Air proving switch (requires min Pt total pressure of .07" w.g. at the face of the electric coil)
- 24V Class 2 control transformer (inherently limiting)
- Magnetic / safety contactors as required (UL listed for minimum of 250,000 cycles)
- Line and control terminal blocks
- Up to 3 steps of heat
- ETL listed assembly

EZTE OPTIONAL FEATURES:

- Door-interlocking disconnect switch (non-fused)
- Main power fuses (fuses and fuse blocks)
- Magnetic disconnecting contactor
- Proportional SSR control (0-100%)
- Discharge temperature limiting control

Table 25: Electric Heating Coil Performance - Allowable KW

Inlet Size	# Steps	1 - Phase								3 - Phase			
		120 V KW Range		208 V KW Range		240 V KW Range		277 V KW Range		208 V KW Range		480 V KW Range	
		Min	Max	Min	Max	Min	Max	Min	Max	Min	Max	Min	Max
5"	1	0.5	4.0	0.5	4.0	0.5	4.0	0.5	4.0	0.5	4.0	1.5	4.0
	2	1.0		1.0		1.0		1.0		1.5			
	3	1.5		1.5		1.5		1.5		-			
6"	1	0.5	5.0	0.5	6.5	0.5	6.0	0.5	6.0	0.5	6.5	1.5	6.5
	2	1.0		1.0		1.0		1.0		1.5			
	3	1.5		1.5		1.5		1.5		-			
7"	1	0.5	5.0	0.5	9.0	0.5	9.0	0.5	7.0	0.5	9.0	1.0	6.0
	2	1.0		1.0		1.0		1.0		1.5			
	3	1.5		1.5		1.5		1.5		3.0			
8"	1	0.5	5.0	0.5	9.0	0.5	10.0	0.5	7.0	0.5	10.5	1.0	6.0
	2	1.0		1.0		1.0		1.0		1.5			
	3	1.5		1.5		1.5		1.5		3.0			
9"	1	0.5	5.0	0.5	9.0	0.5	10.5	0.5	12.0	0.5	15.0	1.0	15.5
	2	1.0		1.0		1.0		1.0		1.5			
	3	1.5		1.5		1.5		1.5		1.5			
10"	1	0.5	5.0	0.5	9.0	0.5	10.5	0.5	12.0	0.5	15.0	1.0	19.0
	2	1.0		1.0		1.0		1.0		1.5			
	3	1.5		1.5		1.5		1.5		1.5			
12"	1	0.5	5.0	0.5	9.0	0.5	10.5	0.5	12.0	0.5	15.0	1.0	23.0
	2	1.0		1.0		1.0		1.0		1.5			
	3	1.5		1.5		1.5		1.5		1.5			
14"	1	0.5	5.0	0.5	9.0	0.5	10.5	0.5	12.0	1.0	15.0	1.0	35.0
	2	1.0		1.0		1.0		1.0		1.5			
	3	1.5		1.5		1.5		1.5		1.5			
16"	1	0.5	5.0	0.5	9.0	0.5	10.5	0.5	12.0	1.0	15.0	1.0	35.0
	2	1.0		1.0		1.0		1.0		1.5			
	3	1.5		1.5		1.5		1.5		1.5			
24 x 16	1	0.5	5.5	0.5	10.0	0.5	11.5	0.5	13.0	1.0	13.0	1.0	30.0
	2	1.0		1.0		1.0		1.0		1.5			
	3	1.5		1.5		1.5		1.5		1.5			

Notes:

1. The Max Allowable KW shown is based on UL / NEC standards, in conjunction with laboratory tests of EZTE air terminal assemblies.
2. The minimum air flow requirement for terminals with electric coils is the greater of 70 cfm/KW or the minimum allowable flow rate that can be accurately controlled. This allows proper operation of the electric coil and results in increased coil life with a maximum air temperature rise of 45° F to prevent thermal stratification in the space. Refer to table 4, page B-10 to determine minimum and maximum flow rates for the control system selected.
3. Uniform flow through a coil results in optimum performance, and therefore, we recommend a minimum length of 48" of full size discharge duct after the air terminal.
4. 480V/3ph heaters may incorporate "wye" or other unbalanced configuration for multiple steps.

Single Duct Air Terminals

B

Table 26: Pneumatic Control Sequences

Control Package #	Pressure Independent	Pressure Dependent	Direct Acting Thermostat	Reverse Acting Thermostat	Damper Normally Open	Damper Normally Closed	Reheat	Morning Warm Up	Summer/Winter Changeover	VAV Cooling & VAV Heating	Dual Minimum (Summer/Winter)	Dual Minimum (Reheat)	Constant Volume	Two Level Constant Volume	Static Pressure Control
SD-P-3100	•		•		•		○								
SD-P-3200	•		•			•	○								
SD-P-3300	•			•	•		○								
SD-P-3400	•			•		•	○								
SD-P-3120	•		•		•		○	•							
SD-P-3220	•		•			•	○	•							
SD-P-3320	•			•	•		○	•							
SD-P-3420	•			•		•	○	•							
SD-P-3140	•		•		•		○		•						
SD-P-3240	•		•			•	○		•						
SD-P-3340	•			•	•		○		•						
SD-P-3440	•			•		•	○		•						
SD-P-3160	•		•		•		○			•					
SD-P-3260	•		•			•	○			•					
SD-P-3360	•			•	•		○			•					
SD-P-3460	•			•		•	○			•					
SD-P-3175	•		•		•		○				•				
SD-P-3275	•		•			•	○				•				
SD-P-3375	•			•	•		○				•				
SD-P-3475	•			•		•	○				•				
SD-P-3180	•		•		•		○					•			
SD-P-3280	•			•		•	○					•			
SD-P-3181	•				•		○						•		
SD-P-3281	•					•	○							•	
SD-P-0001		•	•			•									
SD-P-0002		•		•	•										
SD-P-0003					•										•
SD-P-0004						•									•

Note:
• – standard
○ – optional

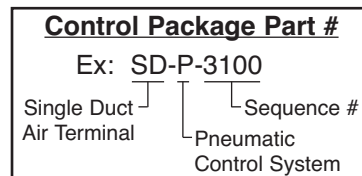
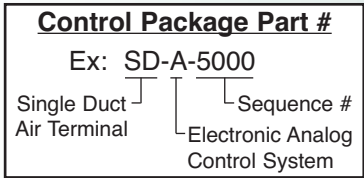

Table 27: Electronic Analog Control Sequences

Control Package #	Pressure Independent	Pressure Dependent	Morning Warm-up	VAV Cooling & VAV Heating	Constant Volume	Static Pressure Control (0-2" w.c. range)	Electric Heat (Staged)	Hot Water Heat (On-Off)	Proportional Modulating Hot Water Heat	Proportional Modulating Electric Heat	Dual Minimum	Two Level Constant Volume
SD-A-5000	•											
SD-A-5001	•					•					○	
SD-A-5002	•						•				○	
SD-A-5003	•							•			○	
SD-A-5004	•								•		○	
SD-A-5020	•		•								○	
SD-A-5021	•		•			•					○	
SD-A-5022	•		•				•				○	
SD-A-5023	•		•					•			○	
SD-A-5024	•		•						•		○	
SD-A-5040	•			•								
SD-A-5041	•			•		•						
SD-A-5042	•			•			•					
SD-A-5043	•			•				•				
SD-A-5044	•			•					•			
SD-A-5080	•				•							
SD-A-5081	•				•	•						
SD-A-5082	•				•		•					
SD-A-5083	•				•			•				
SD-A-5084	•				•				•			
SD-A-5085	•											•
SD-A-5090						•						
SD-A-0001		•										

Note:
• – standard
○ – optional



**VAV Cooling
Pressure Dependent**

Control Packages

SD-P-0001, 0002
SD-A-0001

Sequence of Operation

As the room air temperature increases above the thermostat setpoint, the actuator rotates the terminal damper in response to the thermostat signal towards the open position. If desired, the maximum damper position can be set in the field.

As the room air temperature decreases below the thermostat setpoint, the actuator rotates the terminal damper in response to the thermostat signal towards the closed position. If desired (electronic controls only), the minimum damper position can be set in the field.

Control Package Contents

All pneumatic control packages listed above include the damper actuator. Thermostats are not included.

All electronic control packages listed above include the damper actuator and room thermostat.

Note: Not recommended for optional hot water or electric heat.

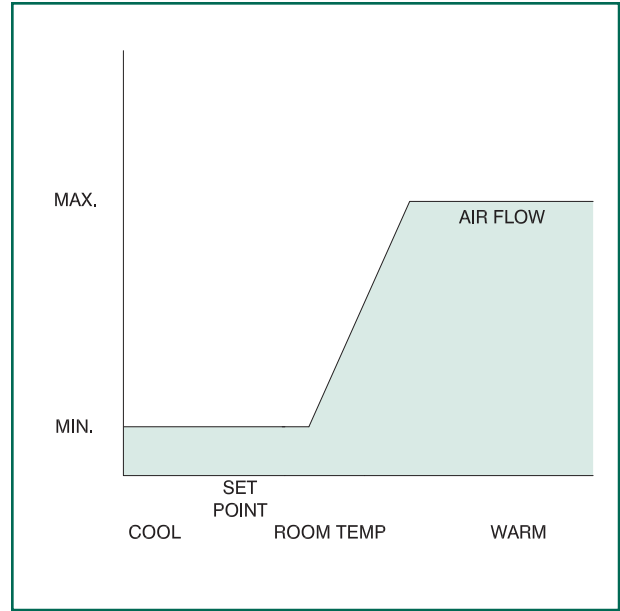

**VAV Cooling
(optional hot water or electric heating)
Pressure Independent**

Control Packages

SD-P-2100 and 2400
SD-P-3100 through 3400
SD-A-5000 through 5004

Sequence of Operation

As the room air temperature increases above the thermostat's setpoint, the actuator rotates the terminal's damper in response to the controller's signal towards the open position up to the maximum airflow setting.

As the room air temperature decreases below the thermostat's setpoint, the actuator rotates the terminal's damper in response to the controller's signal towards the closed position down to the minimum airflow setting.

The controller's signal is determined by comparing the signals from the thermostat and flow sensor to provide the required airflow regardless of the inlet static pressure conditions.

On units provided with heating coils, the heat is activated as the room temperature continues to fall below the thermostat's setpoint after having reached the minimum airflow setting. The airflow remains at the minimum setting while in the heating mode.

Control Package Contents

All pneumatic control packages listed above include the damper actuator and pressure independent controller. Thermostats are not included.

All electronic control packages listed above include the damper actuator, pressure independent controller and room thermostat. A trigger relay is provided with all electronic control packages where hot water (on-off) or electric heating coils are provided.

Control valves for the hot water coils are not included in the control package.

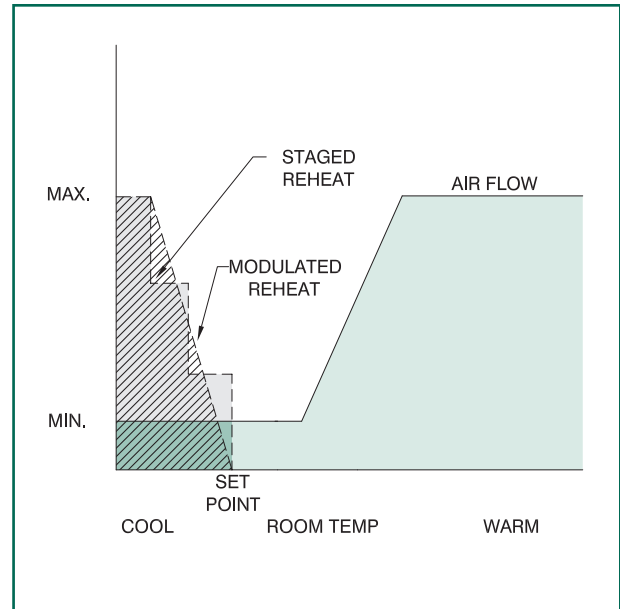

VAV Cooling and Morning Warm-up
(optional hot water or electric heating)
Pressure Independent

Control Packages
SD-P-2120 and 2420
SD-P-3120 through 3420
SD-A-5020 through 5024

Sequence of Operation
As the room air temperature increases above the thermostat's setpoint, the actuator rotates the terminal's damper in response to the controller's signal towards the open position up to the maximum airflow setting.

As the room air temperature decreases below the thermostat's setpoint, the actuator rotates the terminal's damper in response to the controller's signal towards the closed position down to the minimum airflow setting.

The controller's signal is determined by comparing the signals from the thermostat and flow sensor to provide the required airflow regardless of the inlet static pressure conditions.

On units provided with heating coils, the heat is activated as the room temperature continues to fall below the thermostat's setpoint after having reached the minimum airflow setting. The airflow remains at the minimum setting while in the heating mode.

In response to a change in main pressure (with pneumatic controls) or a remote 24 volt signal (with electronic controls), the actuator rotates the damper to the fully open position for morning warm-up.

Control Package Contents

All pneumatic control packages listed above include the damper actuator, pressure independent controller and diverting relay. Thermostats are not included.

All electronic control packages listed above include the damper actuator, pressure independent controller, SPDT relay and room

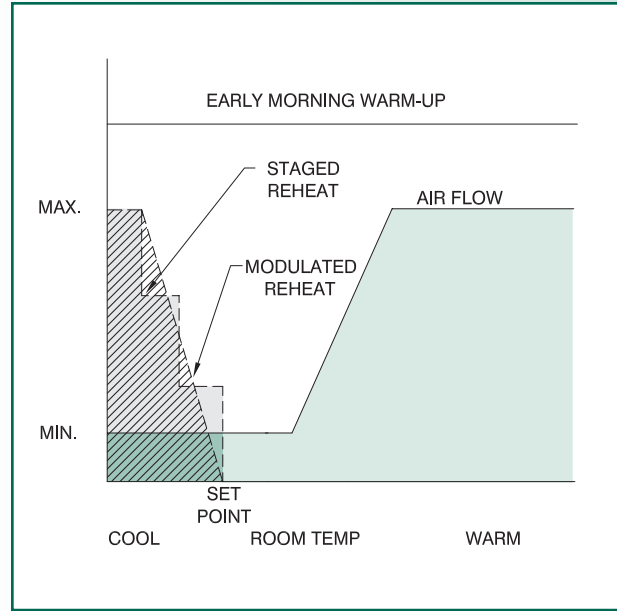

thermostat. A trigger relay is provided with all electronic control packages where hot water (on-off) or electric heating coils are provided.

Control valves for the hot water coils are not included in the control package.

VAV Cooling and VAV Heating
(optional hot water or electric heating)
Pressure Independent

Control Packages
SD-P-2160 and 2460
SD-P-3160 through 3460
SD-A-5040 through 5044

Sequence of Operation
In the cooling mode as the room air temperature increases above the thermostat setpoint, the actuator rotates the terminal damper in response to the controller's signal towards the open position up to the maximum airflow setting.

As the room air temperature decreases below the thermostat setpoint, the actuator rotates the terminal damper in response to the controller's signal towards the closed position down to the minimum airflow setting.

The controller's signal is determined by comparing the signals from the thermostat and flow sensor to provide the required airflow regardless of the inlet static pressure conditions.

As the room temperature continues to fall below the thermostat setpoint and the minimum airflow setting is reached, the heat is activated. As the demand for heat increases, the airflow increases above the minimum setting up to the maximum airflow setting.

In the heating mode in response to a change in main pressure (pneumatic controls) or from a signal from the unit temperature sensor (electronic controls) indicating warm supply air, the actuator rotates the damper in the opposite direction to the cooling mode in response to changes in the room temperature. As the demand for heat increases, the airflow increases above the minimum setting up to the maximum airflow setting.

Control Package Contents

All pneumatic control packages listed above include the damper actuator, pressure independent controller, high pressure selector and reversing relay. Thermostats are not included.

All electronic control packages listed above include the damper

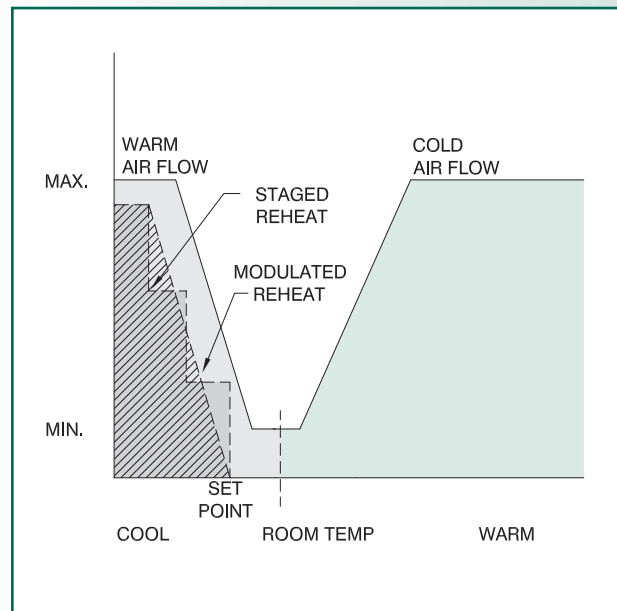

actuator, pressure independent control, temperature sensor, heat/cool changeover module and room thermostat. A trigger relay is provided with all electronic control packages where hot water (on-off) or electric heating coils are provided.

Control valves for the hot water coils are not included in the control package.

**VAV Summer/Winter Changeover
(optional hot water or electric heating)
Pressure Independent**

Control Packages

SD-P-2140 and 2440
SD-P-3140 through 3440
(for electronic control, see VAV Cooling and VAV Heating)

Sequence of Operation

In the summer mode as the room air temperature increases above the thermostat's setpoint, the actuator rotates the terminal's damper in response to the controller's signal towards the open position up to the maximum airflow setting.

As the room air temperature decreases below the thermostat's setpoint, the actuator rotates the terminal's damper in response to the controller's signal towards the closed position down to the minimum airflow setting.

The controller's signal is determined by comparing the signals from the thermostat and flow sensor to provide the required airflow regardless of the inlet static pressure conditions.

On units provided with heating coils, the heat is activated as the room temperature continues to fall below the thermostat's setpoint.

In the winter mode in response to a change in main pressure, the actuator rotates the damper in the opposite direction to the summer mode in response to changes in the room temperature. As the demand for heat increases, the airflow increases above the minimum setting up to the maximum airflow setting.

Control Package Contents

All pneumatic control packages listed above include the damper actuator, pressure independent controller, diverting relay and reversing relay. Thermostats are not included.

Control valves for the hot water coils are not included in the control package.

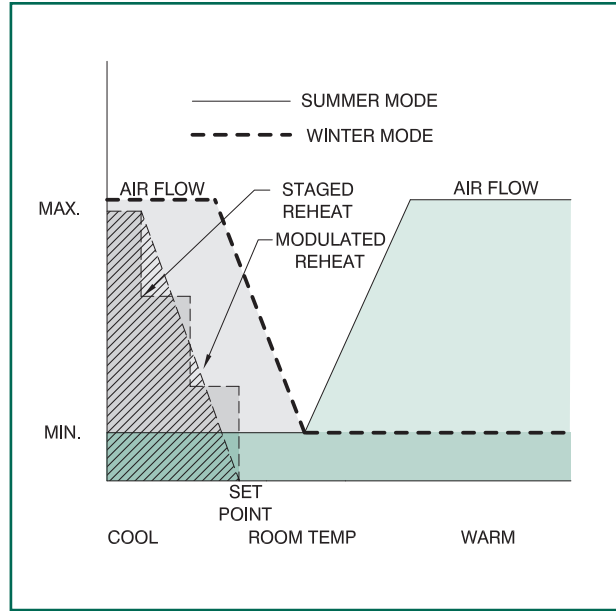

**VAV Cooling with Dual Minimums and
Summer/Winter Changeover
(optional hot water or electric heating)
Pressure Independent**

Control Packages

SD-P-3170 through 3470

Sequence of Operation

In the summer mode as the room air temperature increases above the thermostat setpoint, the actuator rotates the terminal damper in response to the controller's signal towards the open position up to the maximum airflow setting.

As the room air temperature decreases below the thermostat setpoint, the actuator rotates the terminal damper in response to the controller's signal towards the closed position down to the minimum airflow setting.

The controller's signal is determined by comparing the signals from the thermostat and flow sensor to provide the required airflow regardless of the inlet static pressure conditions.

In the winter mode in response to a change in main pressure (pneumatic controls), the actuator rotates the damper in the opposite direction to the summer mode in response to changes in the room temperature. The minimum airflow settings can be different for the summer and winter modes.

On units provided with heating coils, the heat is activated as the room temperature continues to fall below the thermostat setpoint.

Control package Contents

All pneumatic control packages listed above include the damper actuator, pressure independent controller, high pressure selector, reversing relay, diverting relays and pressure regulating valve. Thermostats are not included.

Control valves for the hot water coils are not included in the control package.

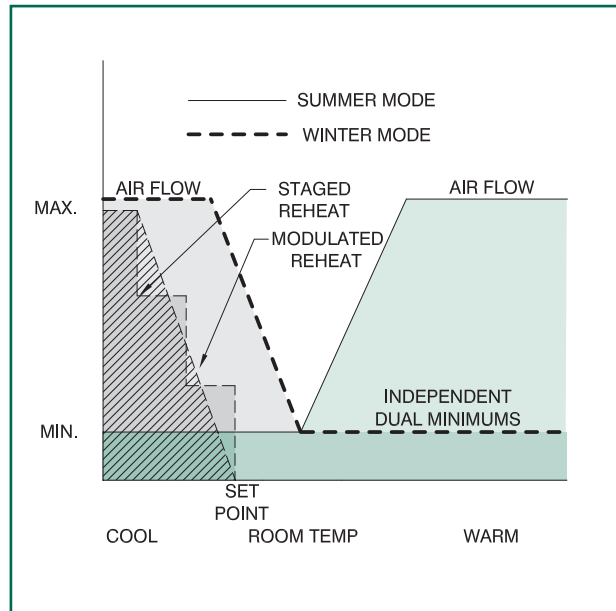

VAV Cooling with Dual Minimums
(optional hot water or electric heating)
Pressure Independent

Control Packages
SD-P-2175 and 2475
SD-P-3175 through 3475
SD-A-5001 through 5004

Sequence of Operation
As the room air temperature increases above the thermostat setpoint, the actuator rotates the terminal damper in response to the controller's signal towards the open position up to the maximum airflow/damper position setting.

As the room air temperature decreases below the thermostat setpoint, the actuator rotates the terminal damper in response to the controller's signal towards the closed position down to the minimum flow setting/damper position..

The controller's signal is determined by comparing the signals from the thermostat and flow sensor to provide the required airflow regardless of the inlet static pressure conditions.

On units provided with heating coils, the heat is activated as the room temperature continues to fall below the thermostat setpoint. A second minimum airflow setting can be different in the heating mode.

Control Package Contents
All pneumatic control packages listed above include the damper actuator, pressure independent controller, diverting relay, low or high pressure selector and pressure regulating valve. Thermostats are not included.

All electronic control packages listed above include the damper actuator, pressure independent controller and room thermostat. The second different minimum airflow setting for the heating mode can be set in the field by installing a jumper between two terminals in the room thermostat. A trigger relay is provided with all electronic control packages where hot water (on-off) or electric heating coils are provided.

Control valves for the hot water coils are not included in the control package.

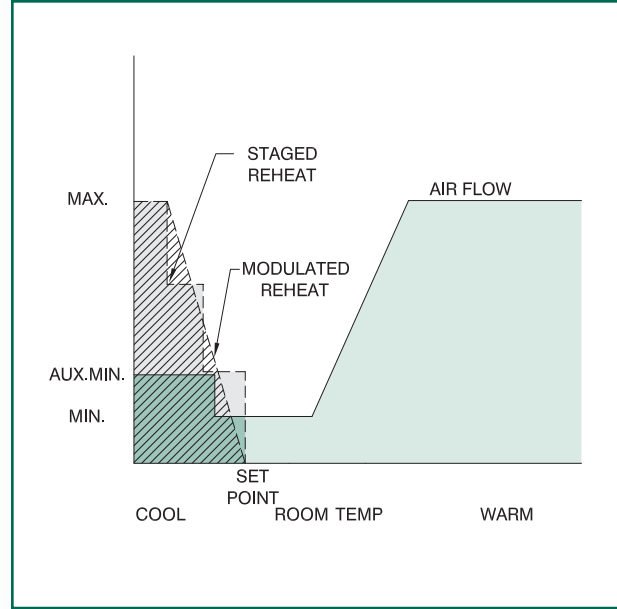

Constant Volume
(optional hot water or electric heating)
Pressure Independent

Control Packages
SD-P-2180 and 2280
SD-P-3180 and 3280
SD-A-5080 through 5084

Sequence of Operation
The damper is rotated in response to the controller's signal to provide a constant volume of airflow regardless of changes in the terminal inlet static pressure.
The controller's signal is determined by the flow sensor signal.

Control Package Contents
All pneumatic control packages listed above include the damper actuator and pressure independent controller. Thermostats are not included.
All electronic control packages listed above include the damper actuator and pressure independent controller. Thermostats are included (only when a heating coil is provided). A trigger relay is provided with all electronic control packages where hot water (on-off) or electric heating coils are provided.

Control valves for the hot water coils are not included in the control package.

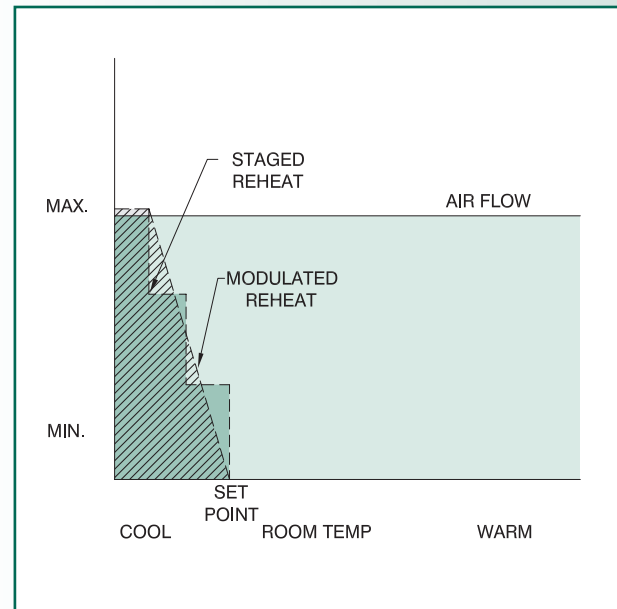

**Two level Constant Volume
(optional hot water or electric heating)
Pressure Independent**

Control Packages

SD-P-2181 and 2281
SD-P-3181 and 3281
SD-A-5085

Sequence of Operation

The damper is rotated in response to the controller's signal to provide a constant volume of airflow regardless of changes in the terminal inlet static pressure.
In response to a change in main pressure (with pneumatic controls) or a remote signal (with electronic controls), a second constant volume setting is maintained.
The controller's signal is determined by the flow sensor signal.

Control Package Contents

All pneumatic control packages listed above include the damper actuator, pressure independent controller (and reversing relay in P2281). Thermostats are not included.
All electronic control packages listed above include the damper actuator and pressure independent controller. Thermostats are included. A trigger relay is provided with all electronic control packages where hot water (on-off) or electric heating coils are provided.

Control valves for the hot water coils are not included in the control package.

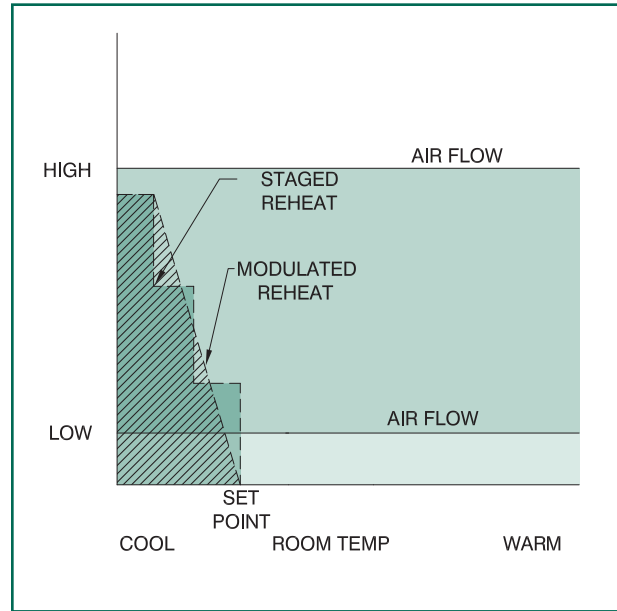

Static Pressure Control

Control Packages

SD-P-0003, 0004
SD-A-5090

Sequence of Operation

The damper is rotated to maintain a constant inlet static pressure.

Control Package Contents

The control packages listed above include the damper actuator and pressure independent controller. Duct pressure sensor and thermostats are not included.

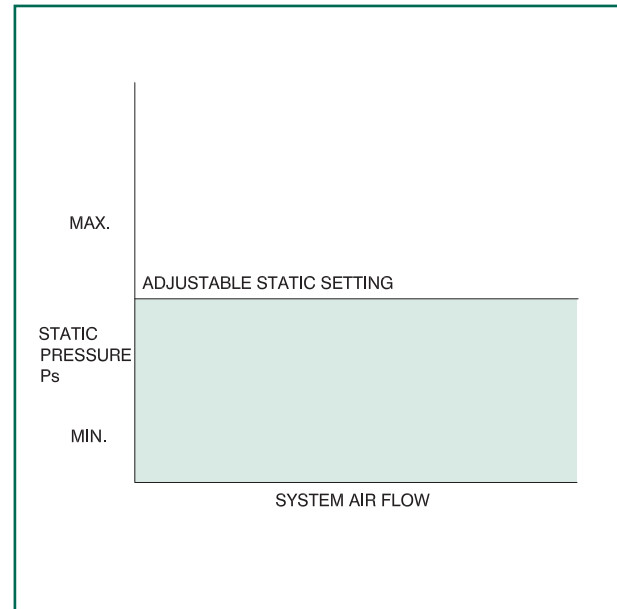

- MODEL**
- EZTS** - Basic Assembly
 - EZTA** - with Integral Sound Attenuator
 - EZTE** - with Integral Electric Heat

- INLET SIZE**
- | | |
|-------------------------------|----------------------------------|
| <input type="checkbox"/> 5" Ø | <input type="checkbox"/> 10" Ø |
| <input type="checkbox"/> 6" Ø | <input type="checkbox"/> 12" Ø |
| <input type="checkbox"/> 7" Ø | <input type="checkbox"/> 14" Ø |
| <input type="checkbox"/> 8" Ø | <input type="checkbox"/> 16" Ø |
| <input type="checkbox"/> 9" Ø | <input type="checkbox"/> 24"x16" |

- CASING CONSTRUCTION**
- Galvanized Steel
 - 304 Stainless Steel
 - 316 Stainless Steel
-
- 22 Gauge
 - 20 Gauge

- CASING TREATMENTS**
- 1/2" Matte Insulation
 - 1" Matte Insulation
 - 1/2" Foil Faced Insulation
 - 1" Foil Faced Insulation
 - 1" Fibre-Lok Insulation
 - 3/8" Fiber-Less Insulation
 - Dual Wall
 - Lo-Temp

- CONTROL SYSTEM**
- Pneumatic Controls
 - Electronic Analog Controls
 - Direct Digital Controls (DDC)
 - Electric Controls
- Control strategies available for all applications

- CONTROL SIDE**
- Right Side
 - Left Side

- REHEAT OPTIONS**
- 1 Row Hot Water Coil
 - 2 Row Hot Water Coil
 - 4 Row Hot Water Coil
 - Electric Coil
-
- Right Hand Connection
 - Left Hand Connection



- ACCESSORIES**
- | | |
|---|---|
| <p>ACCESS DOORS</p> <ul style="list-style-type: none"> <input type="checkbox"/> Bottom <input type="checkbox"/> Side <input type="checkbox"/> Patch Plate <input type="checkbox"/> Hinged Camlock <input type="checkbox"/> Double Camlock | <p>ELECTRIC CONTROLS</p> <ul style="list-style-type: none"> <input type="checkbox"/> Control Transformer <input type="checkbox"/> Low Voltage Control Disconnect Switch <input type="checkbox"/> Low Voltage Fuse & Fuse Block <input type="checkbox"/> Low Voltage Disconnect Switch <input type="checkbox"/> Low Voltage Power-Fusing <input type="checkbox"/> 24 VAC Actuator |
| <p>CASING OPTIONS</p> <ul style="list-style-type: none"> <input type="checkbox"/> Unit Mounting Bracket (shipped loose) <input type="checkbox"/> Manual Damper Locking <input type="checkbox"/> Standard Control Enclosure <input type="checkbox"/> Large Control Enclosure <input type="checkbox"/> Hinged Front Panel (control enclosure) <input type="checkbox"/> Lo-Leakage Casing | |

- ELECTRIC COILS**
- | | |
|------------------------------------|------------------------------------|
| <input type="checkbox"/> 120 Volts | <input type="checkbox"/> 277 Volts |
| <input type="checkbox"/> 208 Volts | <input type="checkbox"/> 480 Volts |
| <input type="checkbox"/> 240 Volts | |
-
- | | |
|----------------------------------|----------------------------------|
| <input type="checkbox"/> 1 Phase | <input type="checkbox"/> 3 Phase |
|----------------------------------|----------------------------------|
-
- | | |
|---------------------------------|---------------------------------|
| <input type="checkbox"/> 1 Step | <input type="checkbox"/> 3 Step |
| <input type="checkbox"/> 2 Step | |
-
- Door Interlocking Disconnect Switch, Non-Fused
 - Power Fusing
 - Primary Fused Transformer

Furnish and install Anemostat EZTS Single Duct Variable Air Volume Terminals, EZTA Single Duct Variable Air Volume Terminals with integral sound attenuator, or EZTE Single Duct Variable Air Volume Terminals with integral electric heating coil as shown on the plans. The performance of all Single Duct Terminals shall be certified under ARI Standard 880 and must display the required ARI 880 Certification Seal. Discharge and radiated sound power levels shall not exceed the values as shown on the terminal unit schedule.

Casing Construction:

The unit casing shall be fabricated from zinc coated steel and use mechanical locking seams to form a leak resistant assembly. Any sealant used in the unit's construction must be approved for duct use and conform to NFPA 90A. Leakage through the Air Terminal casing shall be less than 1% of the maximum rated air flow @ 3" w.g. static pressure. (Optional Lo-Leak casing spec: Leakage through the Air Terminal casing shall be no more than 3 CFM @ 1" w.g. static pressure). The terminal discharge connection shall be Slip & Drive type integral to the casing.

The casing shall be:

- 22 gauge (standard)
- 20 gauge

The casing shall be provided with:

- 6"x6" bottom access plate
- 6"x6" bottom access door with hinge and camlock
- 6"x6" bottom removable access door with two camlocks
- 6"x6" side access plate
- 6"x6" side access door with hinge and camlock
- 6"x6" side removable access door with two camlocks
- Unit mounting brackets
- Manual damper locking quadrant
- Standard control enclosure
- Universal (larger) control enclosure
- Hinged front cover for control enclosure

Insulation and Treatment:

The unit casing shall be internally lined with:

- 1/2" thick matte-faced dual density glass fiber insulation that conforms to NFPA-90A and UL 181.
- 1" thick matte-faced dual density glass fiber insulation that conforms to NFPA-90A and UL 181.
- 1/2" thick aluminum foil-faced dual density glass fiber insulation. The edges of the insulation shall be sealed with aluminum tape. The insulation shall conform to NFPA 90A, UL 181, and ASTM C665.
- 1" thick aluminum foil-faced dual density glass fiber insulation. The edges of the insulation shall be sealed with aluminum tape. The insulation shall conform to NFPA 90A, UL 181, and ASTM C665.

- 1" thick aluminum foil-faced dual density glass fiber Fibre-Lok insulation. The edges of the insulation shall be sealed by zinc-coated steel that locks the adjacent edges of the insulation. The insulation shall conform to NFPA 90A, UL 181, and ASTM C665.
- 1/2" thick dual density glass fiber insulation with a 22 gauge non-perforated sheet metal liner, covering all fiber insulation surfaces. The construction shall conform to NFPA 90A, UL 181, and ASTM C665.
- 3/8" thick (fiber-less) smooth skin surface closed cell foam insulation. The insulation shall conform to NFPA 255 and UL 181.
- No Insulation

Air Valve:

The damper assembly shall consist of a round blade that requires nominal 90-degree rotation from fully opened to fully closed positions on sizes 05 through 16. The damper blade shall be mechanically attached to the die-cast metal damper shaft with through the shaft machine-applied rivets. The low leakage damper shall be constructed of a gasket material sandwiched between two 22-gauge zinc coated steel plates. Leakage through the damper shall be less than 1% of the maximum rated airflow at 3" w.g. inlet static pressure. The damper gasket material is securely fastened between the two damper plates using machine applied rivets. The damper assembly shall rotate freely in self-lubricating bearings. Damper position shall be indicated on the end of the shaft on the outside of the casing. Inlet connection and damper on size 24 x 16 shall be rectangular.

Airflow Sensor:

A multi-point airflow sensor (Velocity Wing) of the center averaging type shall be located in the terminal inlet. The airflow sensor shall be aerodynamically designed to provide low pressure loss, quiet operation and have not less than 20 sensing points on any given size unit. The sensor shall amplify the velocity pressure signal and provide feedback of actual flow to the controller.

An identification label with piping/wiring diagram and airflow calibration chart shall be affixed to each unit. Flow taps with caps, separate from the airflow sensor or controller taps shall be provided for flow readjustment.

Pneumatic Controls:

The pneumatic controls shall be suitable for a 20-psi control system. The sequence of operation is based on Anemostat Control Package (as listed on page B-26 of this catalog). The pneumatic actuator shall be furnished and mounted by the terminal manufacturer to move the damper from fully open to fully closed positions. The actuator shall be directly coupled to the damper shaft with no linkages. The actuator shall develop a minimum of 42 inch-pounds of torque at 5 psi.

The damper shall be:

- Normally open
- Normally closed
- A pneumatic pressure independent controller shall be furnished and mounted by the terminal manufacturer, and shall control flow within +/-5% of the design air flow regardless of changes in system static pressure. The controller shall reset the flow as required by the thermostat. The maximum and minimum airflow set points shall be set at the factory.

The pneumatic thermostats shall be provided and installed by the temperature control contractor. It shall be the responsibility of the temperature control contractor to coordinate their requirements with those of the terminal manufacturer.

Electronic analog controls:

The electronic analog controls shall be suitable for a 24-volt control system. The sequence of operation is based on Anemostat Control Package (as listed on page B-27 of this catalog). The electronic actuator shall be furnished and mounted by the terminal manufacturer to move the damper from fully open to fully closed positions. The actuator shall be directly coupled to the damper shaft with no linkages.

- The electronic pressure independent controller shall control flow within +/-5% of the design airflow regardless of changes in system static pressure. The controller shall reset the flow as required by the thermostat. The maximum and minimum airflow set points shall be set at the factory.

The electronic actuator and controller shall be combined in a single compact housing. The electronic actuator shall be designed for permanent stall without damage and develop a minimum of 50 inch-pounds of torque.

The terminal shall also be provided with:

- Transformer to step down incoming line voltage to 24 volts (standard on EZTE units with electric heating coils)
- Service disconnect switch for 24 volt controls (pilot duty)
- Low voltage fuse and fuse block
- Line voltage disconnect switch
- Line voltage fusing and fuse block

The wall thermostat shall be furnished by the terminal manufacturer for installation by the temperature control contractor. Flow adjustments shall be made at the wall thermostat utilizing a digital voltmeter.

It shall be the responsibility of the temperature control contractor to coordinate these requirements with those of the terminal manufacturer.

DDC Controls

Terminal manufacturer shall mount DDC controls provided by others. All mounting hardware should be provided by the DDC control supplier. It shall be the responsibility of the DDC supplier to coordinate and provide job specific wiring diagrams to the terminal manufacturer.

Hot Water Coils:

Where shown on the plans, hot water heating coils shall be provided and mounted by the terminal manufacturer. The hot water coils shall be mounted at the discharge of the terminal unit, and the coil shall have a Slip & Drive type connection for attachment to the downstream ductwork. Coils shall be 1/2" copper tubing mechanically expanded in aluminum fins. Coils shall be leak tested with dry nitrogen to 400 psi with a minimum burst pressure of 2500 psi. The performance of all hot water coils shall be rated in accordance with ARI standard 410. Refer to the terminal schedule on the plans for capacities and performance requirements. The sequencing of the airflow and water valve shall be controlled as defined by the Anemostat control package (as listed on page B-26 and 27 of this catalog). The water control valves shall be furnished and installed by others and not by the terminal manufacturer.

Electric Heating Coils:

Where shown on the plans, electric resistance type heating coils and coil controls shall be provided and mounted by the terminal manufacturer. The electric coils shall be located a sufficient distance downstream of the primary air damper to prevent hot spots and nuisance tripping.

The heating elements shall be installed as an integral part of the terminal unit. All terminals with electric heat shall be ETL listed, and include high grade nickel-chrome elements, a transformer, air proving switch, primary disc type automatic reset hi-limit, secondary hi-limit manual reset cutout, magnetic contactors and/or PE switches per step, grounding terminal, and circuit fusing on heaters exceeding 48 amps. Coil panel and frame shall be constructed from aluminized or galvanized steel. A wiring diagram shall be permanently affixed to the coil control enclosure panel. Refer to the terminal schedule on the plans for capacity and performance requirements.

- In Pneumatic control systems, the temperature control contractor shall be responsible for connecting pneumatic signal lines to the coil for proper sequencing
- In Electronic analog control systems, the terminal manufacturer shall interconnect the electronic controls with the electric coil for proper staging of heat. Power connection for the coil and associated flow controls shall be made at a single point.

The coils shall also be provided with:

- Door interlocking disconnect switch – non-fused
- Power-fusing (Fuses and fuse blocks)
- SSR/SCR proportional modulating controller
- Class 2 Transformer (inherently limiting)

Low Temperature Units:

Low temperature units shall be capable of handling 40 degree F air without condensation forming on the terminal casing at ambient conditions of 80 degrees F and 60 percent relative humidity. The unit casing shall be lined with 1" dual density glass fiber insulation. The air valve shall be thermally isolated from the unit casing.